

Highline Fifty Credenzas Index

66"-114" width

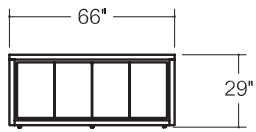

03C66C

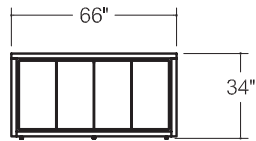

03C66B

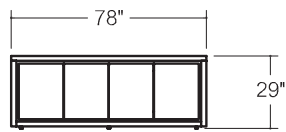

03C78C

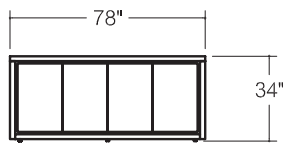

03C78B

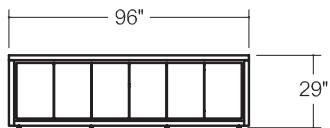

03C96C

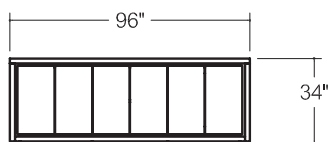

03C96B

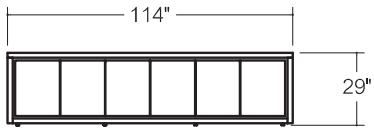

03C114C

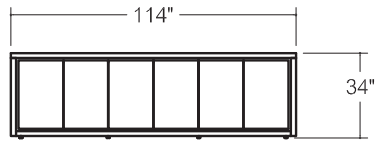

03C114B

Highline Fifty Credenza

66" Long, 34" Buffet Height

03C66B

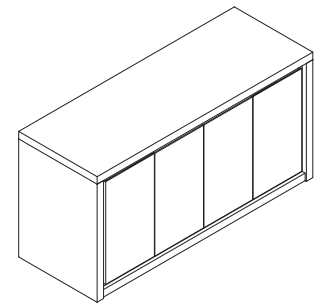

Starting Price: **\$11,508**

66" credenza, 34" high, no top, all doors, satin lacquer case and doors, matching interior finish reveal

Pattern Number: 03C66B

Step 1. Top

NT	No top
FT	Full Top

Step 2. Top Finish (not applicable in 'no top' configuration)

GC00	Clear Glass	+2,008
GC01	Clear Glass, back painted, white	+2,114
GC __	Clear Glass, back painted, color	+2,349
GE01	Etched matte Glass, back painted, white	+2,288
GE __	Etched matte Glass, back painted, color	+2,541
CS01	Corian Glacier White	+2,648
QS __	Caesarstone	+3,708

Step 3. Shell Finish

SL __	Satin Lacquer	+0
T1	Veneer Tier 1	+1,744
T2	Veneer Tier 2	+3,017
T3	Veneer Tier 3	+5,548
HG __	High Gloss Polyester	+5,837

Step 4. Reveal Finish

MI __	Match Interior	+0
MC __	Powder Coat	+563
PM01	Polished Chrome	+563
PM02	Satin Nickel	+563
PM03	Oil Rubbed Bronze	+563

Step 5. Interior Finish

SL __	Satin Lacquer	+0
T1 __	Veneer Tier 1	+1,059
T2 __	Veneer Tier 2	+1,273
T3 __	Veneer Tier 3	+4,029
HG __	High Gloss Polyester	+4,330

Step 6. Door/Drawer Face Finish

SL __	Satin Lacquer	+0
T1 __	Veneer Tier 1	+519
T2 __	Veneer Tier 2	+1,011
T3 __	Veneer Tier 3	+1,985
HG __	High Gloss Polyester	+2,194

Step 7. Configuration

Specify Left to Right: Select single or double space components for 4 available positions. When any double space component is selected, insert code in desired starting position and XXXX in subsequent position.

03 ____ B	Position 1
03 ____ B	Position 2
03 ____ B	Position 3
03 ____ B	Position 4

DOUBLE SPACE COMPONENTS

03DR30B	Doors w/adjustable shelf	0
03FF30B	Lateral File over Lateral File	332
03OF30B	Open over Lateral File	310
03DD30B	Drawer over Doors	407
03TP30B	Trash Pullout	1,049
03AV30B	2 Door AV	375

SINGLE SPACE COMPONENTS

03DR15B	Door w/adjustable shelf	0
03FF15B	File over File	166
03OF15B	Open over File	155
03DD15B	Drawer over Door	203
03TP15B	Trash Pullout	524

Please consult [page 7](#) for the palette of DatesWeiser finishes. Natural stone, non-standard glass and veneer, and other technology options are available. Please email customerservice@datesweiser.com for a custom quote. Consult technical information on [page 319](#) for construction and technical details.

Highline Fifty Credenza

78" Long, 34" Buffet Height

03C78B

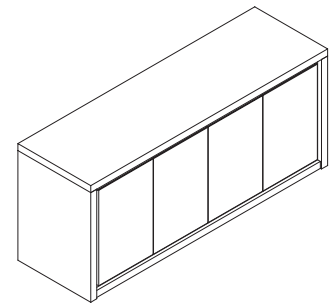

Starting Price: **\$12,430**

78" credenza, 34" high, no top, all doors, satin lacquer case and doors, matching interior finish reveal

Pattern Number: 03C78B

Step 1. Top

NT	No top
FT	Full Top

Step 2. Top Finish (not applicable in 'no top' configuration)

GC00	Clear Glass	+2,013
GC01	Clear Glass, back painted, white	+2,119
GC __	Clear Glass, back painted, color	+2,354
GE01	Etched matte Glass, back painted, white	+2,292
GE __	Etched matte Glass, back painted, color	+2,547
CS01	Corian Glacier White	+2,654
QS __	Caesarstone	+3,715

Step 3. Shell Finish

SL __	Satin Lacquer	+0
T1	Veneer Tier 1	+1,846
T2	Veneer Tier 2	+3,242
T3	Veneer Tier 3	+6,040
HG __	High Gloss Polyester	+6,393

Step 4. Reveal Finish

MI __	Match Interior	+0
MC __	Powder Coat	+563
PM01	Polished Chrome	+563
PM02	Satin Nickel	+563
PM03	Oil Rubbed Bronze	+563

Step 5. Interior Finish

SL __	Satin Lacquer	+0
T1 __	Veneer Tier 1	+1,188
T2 __	Veneer Tier 2	+2,338
T3 __	Veneer Tier 3	+4,612
HG __	High Gloss Polyester	+4,957

Step 6. Door/Drawer Face Finish

SL __	Satin Lacquer	+0
T1 __	Veneer Tier 1	+519
T2 __	Veneer Tier 2	+1,011
T3 __	Veneer Tier 3	+1,985
HG __	High Gloss Polyester	+2,194

Step 7. Configuration

Specify Left to Right: Select single or double space components for 4 available positions. When any double space component is selected, insert code in desired starting position and XXXX in subsequent position.

03 ____ B	Position 1
03 ____ B	Position 2
03 ____ B	Position 3
03 ____ B	Position 4

DOUBLE SPACE COMPONENTS

03DR36B	Doors w/adjustable shelf	0
03FF36B	Lateral File over Lateral File	342
03OF36B	Open over Lateral File	321
03DD36B	Drawer over Doors	417
03TP36B	Trash Pullout	1,059
03AV36B	2 Door AV	449

SINGLE SPACE COMPONENTS

03DR18B	Door w/adjustable shelf	0
03FF18B	File over File	171
03OF85B	Open over File	161
03DD18B	Drawer over Door	209
03TP18B	Trash Pullout	530

Please consult [page 7](#) for the palette of DatesWeiser finishes. Natural stone, non-standard glass and veneer, and other technology options are available. Please email customerservice@datesweiser.com for a custom quote. Consult technical information on [page 319](#) for construction and technical details.

Highline Fifty Credenza

96" Long, 34" Buffet Height

03C96B

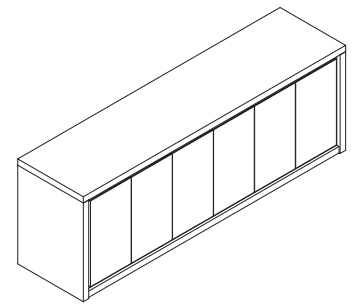

Starting Price: **\$14,912**

96" credenza, 34" high, no top, all doors, satin lacquer case and doors, matching interior finish reveal

Pattern Number: 03C96B

Step 1. Top

NT	No top
FT	Full Top

Step 2. Top Finish (not applicable in 'no top' configuration)

GC00	Clear Glass	+2,500
GC01	Clear Glass, back painted, white	+2,615
GC __	Clear Glass, back painted, color	+2,905
GE01	Etched matte Glass, back painted, white	+2,837
GE __	Etched matte Glass, back painted, color	+3,151
CS01	Corian Glacier White	+3,338
QS __	Caesarstone	+4,674

Step 3. Shell Finish

SL __	Satin Lacquer	+0
T1	Veneer Tier 1	+2,033
T2	Veneer Tier 2	+3,617
T3	Veneer Tier 3	+6,768
HG __	High Gloss Polyester	+7,249

Step 4. Reveal Finish

MI __	Match Interior	+0
MC __	Powder Coat	+563
PM01	Polished Chrome	+563
PM02	Satin Nickel	+563
PM03	Oil Rubbed Bronze	+563

Step 5. Interior Finish

SL __	Satin Lacquer	+0
T1 __	Veneer Tier 1	+1,519
T2 __	Veneer Tier 2	+2,964
T3 __	Veneer Tier 3	+5,832
HG __	High Gloss Polyester	+6,269

Step 6. Door/Drawer Face Finish

SL __	Satin Lacquer	+0
T1 __	Veneer Tier 1	+749
T2 __	Veneer Tier 2	+1,461
T3 __	Veneer Tier 3	+2,873
HG __	High Gloss Polyester	+3,568

Step 7. Configuration

Specify Left to Right: Select single or double space components for 6 available positions. When any double space component is selected, insert code in desired starting position and XXXX in subsequent position.

03 ____ B	Position 1
03 ____ B	Position 2
03 ____ B	Position 3
03 ____ B	Position 4
03 ____ B	Position 5
03 ____ B	Position 6

DOUBLE SPACE COMPONENTS

03DR30B	Doors w/adjustable shelf	0
03FF30B	Lateral File over Lateral File	332
03OF30B	Open over Lateral File	310
03DD30B	Drawer over Doors	407
03TP30B	Trash Pullout	1,049
03AV30B	2 Door AV	375

SINGLE SPACE COMPONENTS

03DR15B	Door w/adjustable shelf	0
03FF15B	File over File	166
03OF15B	Open over File	155
03DD15B	Drawer over Door	203
03TP15B	Trash Pullout	524

Please consult **page 7** for the palette of DatesWeiser finishes. Natural stone, non-standard glass and veneer, and other technology options are available. Please email customerservice@datesweiser.com for a custom quote. Consult technical information on **page 319** for construction and technical details.

Highline Fifty Credenza

114" Long, 34" Buffet Height

03C114B

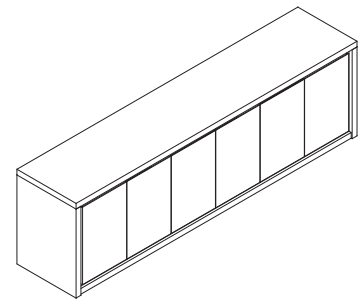

Starting Price: **\$16,258**

114" credenza, 34" high, no top, all doors, satin lacquer case and doors, matching interior finish reveal

Pattern Number: 03C114B

Step 1. Top

NT	No top
FT	Full Top

Step 2. Top Finish (not applicable in 'no top' configuration)

GC00	Clear Glass	+3,838
GC01	Clear Glass, back painted, white	+3,963
GC__	Clear Glass, back painted, color	+4,403
GE01	Etched matte Glass, back painted, white	+4,247
GE__	Etched matte Glass, back painted, color	+4,719
CS01	Corian Glacier White	+4,901
QS__	Caesarstone	+6,681

Step 3. Shell Finish

SL__	Satin Lacquer	+0
T1	Veneer Tier 1	+2,183
T2	Veneer Tier 2	+3,943
T3	Veneer Tier 3	+7,474
HG__	High Gloss Polyester	+8,111

Step 4. Reveal Finish

MI__	Match Interior	+0
MC__	Powder Coat	+648
PM01	Polished Chrome	+648
PM02	Satin Nickel	+648
PM03	Oil Rubbed Bronze	+648

Step 5. Interior Finish

SL__	Satin Lacquer	+0
T1__	Veneer Tier 1	+1,621
T2__	Veneer Tier 2	+3,306
T3__	Veneer Tier 3	+6,623
HG__	High Gloss Polyester	+7,120

Step 6. Door/Drawer Face Finish

SL__	Satin Lacquer	+0
T1__	Veneer Tier 1	+797
T2__	Veneer Tier 2	+1,632
T3__	Veneer Tier 3	+3,264
HG__	High Gloss Polyester	+3,831

Step 7. Configuration

Specify Left to Right: Select single or double space components for 6 available positions. When any double space component is selected, insert code in desired starting position and XXXX in subsequent position.

03_____B	Position 1
03_____B	Position 2
03_____B	Position 3
03_____B	Position 4
03_____B	Position 5
03_____B	Position 6

DOUBLE SPACE COMPONENTS

03DR36B	Doors w/adjustable shelf	0
03FF36B	Lateral File over Lateral File	342
03OF36B	Open over Lateral File	321
03DD36B	Drawer over Doors	417
03TP36B	Trash Pullout	1,059
03AV36B	2 Door AV	449

SINGLE SPACE COMPONENTS

03DR18B	Door w/adjustable shelf	0
03FF18B	File over File	171
03OF85B	Open over File	161
03DD18B	Drawer over Door	209
03TP18B	Trash Pullout	530

Please consult [page 7](#) for the palette of DatesWeiser finishes. Natural stone, non-standard glass and veneer, and other technology options are available. Please email customerservice@datesweiser.com for a custom quote. Consult technical information on [page 319](#) for construction and technical details.

Highline Fifty Credenza

66" Long, 29" Conference Height

03C66C

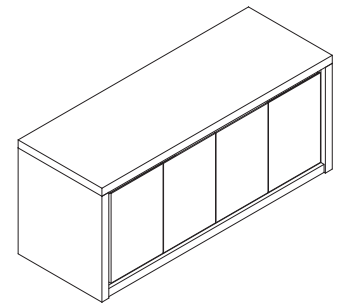

Starting Price: **\$11,508**

66" credenza, 29" high, no top, all doors, satin lacquer case and doors, matching interior finish reveal

Pattern Number: 03C66C

Step 1. Top

NT	No top
FT	Full Top

Step 2. Top Finish (not applicable in 'no top' configuration)

GC00	Clear Glass	+2,008
GC01	Clear Glass, back painted, white	+2,114
GC __	Clear Glass, back painted, color	+2,349
GE01	Etched matte Glass, back painted, white	+2,288
GE __	Etched matte Glass, back painted, color	+2,541
CS01	Corian Glacier White	+2,648
QS __	Caesarstone	+3,708

Step 3. Shell Finish

SL __	Satin Lacquer	+0
T1	Veneer Tier 1	+1,744
T2	Veneer Tier 2	+3,017
T3	Veneer Tier 3	+5,548
HG __	High Gloss Polyester	+5,837

Step 4. Reveal Finish

MI __	Match Interior	+0
MC __	Powder Coat	+563
PM01	Polished Chrome	+563
PM02	Satin Nickel	+563
PM03	Oil Rubbed Bronze	+563

Step 5. Interior Finish

SL __	Satin Lacquer	+0
T1 __	Veneer Tier 1	+1,059
T2 __	Veneer Tier 2	+1,273
T3 __	Veneer Tier 3	+4,029
HG __	High Gloss Polyester	+4,330

Step 6. Door/Drawer Face Finish

SL __	Satin Lacquer	+0
T1 __	Veneer Tier 1	+519
T2 __	Veneer Tier 2	+1,011
T3 __	Veneer Tier 3	+1,985
HG __	High Gloss Polyester	+2,194

Step 7. Configuration

Specify Left to Right: Select single or double space components for 4 available positions. When any double space component is selected, insert code in desired starting position and XXXX in subsequent position.

03 ____ C	Position 1
03 ____ C	Position 2
03 ____ C	Position 3
03 ____ C	Position 4

DOUBLE SPACE COMPONENTS

03DR30C	Doors w/adjustable shelf	0
03DF30C	Drawer over Lateral File	332
03OF30C	Open over Lateral File	310
03DD30C	Drawer over Doors	407
03TP30C	Trash Pullout	1,049
03AV30C	2 Door AV	375

SINGLE SPACE COMPONENTS

03DR15C	Door w/adjustable shelf	0
03DF15C	Drawer over File	166
03OF15C	Open over File	155
03DD15C	Drawer over Door	203
03TP15C	Trash Pullout	524

Please consult [page 7](#) for the palette of DatesWeiser finishes. Natural stone, non-standard glass and veneer, and other technology options are available. Please email customerservice@datesweiser.com for a custom quote. Consult technical information on [page 319](#) for construction and technical details.

Highline Fifty Credenza

78" Long, 29" Conference Height

03C78C

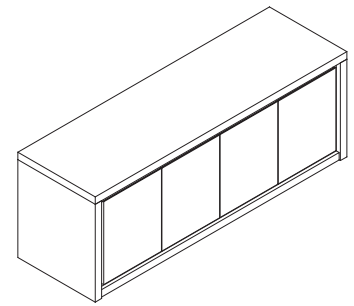

Starting Price: **\$12,430**

78" credenza, 29" high, no top, all doors, satin lacquer case and doors, matching interior finish reveal

Pattern Number: 03C78C

Step 1. Top

NT	No top
FT	Full Top

Step 2. Top Finish (not applicable in 'no top' configuration)

GC00	Clear Glass	+2,013
GC01	Clear Glass, back painted, white	+2,119
GC __	Clear Glass, back painted, color	+2,354
GE01	Etched matte Glass, back painted, white	+2,292
GE __	Etched matte Glass, back painted, color	+2,547
CS01	Corian Glacier White	+2,654
QS __	Caesarstone	+3,715

Step 3. Shell Finish

SL __	Satin Lacquer	+0
T1	Veneer Tier 1	+1,846
T2	Veneer Tier 2	+3,242
T3	Veneer Tier 3	+6,040
HG __	High Gloss Polyester	+6,393

Step 4. Reveal Finish

MI __	Match Interior	+0
MC __	Powder Coat	+563
PM01	Polished Chrome	+563
PM02	Satin Nickel	+563
PM03	Oil Rubbed Bronze	+563

Step 5. Interior Finish

SL __	Satin Lacquer	+0
T1 __	Veneer Tier 1	+1,188
T2 __	Veneer Tier 2	+2,338
T3 __	Veneer Tier 3	+4,612
HG __	High Gloss Polyester	+4,957

Step 6. Door/Drawer Face Finish

SL __	Satin Lacquer	+0
T1 __	Veneer Tier 1	+519
T2 __	Veneer Tier 2	+1,011
T3 __	Veneer Tier 3	+1,985
HG __	High Gloss Polyester	+2,194

Step 7. Configuration

Specify Left to Right: Select single or double space components for 4 available positions. When any double space component is selected, insert code in desired starting position and XXXX in subsequent position.

03 ____ C	Position 1
03 ____ C	Position 2
03 ____ C	Position 3
03 ____ C	Position 4

DOUBLE SPACE COMPONENTS

03DR36C	Doors w/adjustable shelf	0
03FF36C	Drawer over Lateral File	342
03OF36C	Open over Lateral File	321
03DD36C	Drawer over Doors	417
03TP36C	Trash Pullout	1,059
03AV36C	2 Door AV	449

SINGLE SPACE COMPONENTS

03DR18C	Door w/adjustable shelf	0
03FF18C	Drawer over File	171
03OF85C	Open over File	161
03DD18C	Drawer over Door	209
03TP18C	Trash Pullout	530

Please consult [page 7](#) for the palette of DatesWeiser finishes. Natural stone, non-standard glass and veneer, and other technology options are available. Please email customerservice@datesweiser.com for a custom quote. Consult technical information on [page 319](#) for construction and technical details.

Highline Fifty Credenza

96" Long, 29" Conference Height

03C96C

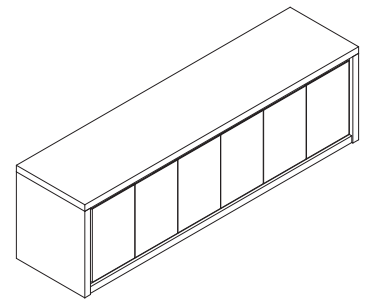

Starting Price: **\$14,912**

96" credenza, 29" high, no top, all doors, satin lacquer case and doors, matching interior finish reveal

Pattern Number: 03C96C

Step 1. Top

NT	No top
FT	Full Top

Step 2. Top Finish (not applicable in 'no top' configuration)

GC00	Clear Glass	+2,500
GC01	Clear Glass, back painted, white	+2,615
GC __	Clear Glass, back painted, color	+2,905
GE01	Etched matte Glass, back painted, white	+2,837
GE __	Etched matte Glass, back painted, color	+3,151
CS01	Corian Glacier White	+3,338
QS __	Caesarstone	+4,674

Step 3. Shell Finish

SL __	Satin Lacquer	+0
T1	Veneer Tier 1	+2,033
T2	Veneer Tier 2	+3,617
T3	Veneer Tier 3	+6,768
HG __	High Gloss Polyester	+7,249

Step 4. Reveal Finish

MI __	Match Interior	+0
MC __	Powder Coat	+563
PM01	Polished Chrome	+563
PM02	Satin Nickel	+563
PM03	Oil Rubbed Bronze	+563

Step 5. Interior Finish

SL __	Satin Lacquer	+0
T1 __	Veneer Tier 1	+1,519
T2 __	Veneer Tier 2	+2,964
T3 __	Veneer Tier 3	+5,832
HG __	High Gloss Polyester	+6,269

Step 6. Door/Drawer Face Finish

SL __	Satin Lacquer	+0
T1 __	Veneer Tier 1	+749
T2 __	Veneer Tier 2	+1,461
T3 __	Veneer Tier 3	+2,873
HG __	High Gloss Polyester	+3,568

Step 7. Configuration

Specify Left to Right: Select single or double space components for 6 available positions. When any double space component is selected, insert code in desired starting position and XXXX in subsequent position.

03 ____ C	Position 1
03 ____ C	Position 2
03 ____ C	Position 3
03 ____ C	Position 4
03 ____ C	Position 5
03 ____ C	Position 6

DOUBLE SPACE COMPONENTS

03DR30C	Doors w/adjustable shelf	0
03DF30C	Drawer over Lateral File	332
03OF30C	Open over Lateral File	310
03DD30C	Drawer over Doors	407
03TP30C	Trash Pullout	1,049
03AV30C	2 Door AV	375

SINGLE SPACE COMPONENTS

03DR15C	Door w/adjustable shelf	0
03DF15C	Drawer over File	166
03OF15C	Open over File	155
03DD15C	Drawer over Door	203
03TP15C	Trash Pullout	524

Please consult [page 7](#) for the palette of DatesWeiser finishes. Natural stone, non-standard glass and veneer, and other technology options are available. Please email customerservice@datesweiser.com for a custom quote. Consult technical information on [page 319](#) for construction and technical details.

Highline Fifty Credenza

114" Long, 29" Conference Height
03C114C

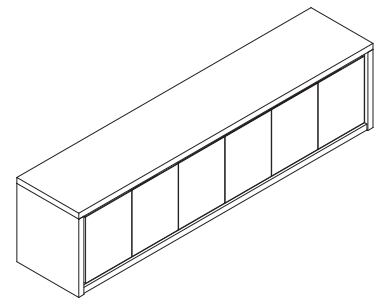

Starting Price: **\$16,258**

114" credenza, 29" high, no top, all doors, satin lacquer case and doors, matching interior finish reveal

Pattern Number: 03C114C

Step 1. Top

NT	No top
FT	Full Top

Step 2. Top Finish (not applicable in 'no top' configuration)

GCO0	Clear Glass	+3,838
GCO1	Clear Glass, back painted, white	+3,963
GC __	Clear Glass, back painted, color	+4,403
GE01	Etched matte Glass, back painted, white	+4,247
GE __	Etched matte Glass, back painted, color	+4,719
CS01	Corian Glacier White	+4,901
QS __	Caesarstone	+6,861

Step 3. Shell Finish

SL __	Satin Lacquer	+0
T1	Veneer Tier 1	+2,183
T2	Veneer Tier 2	+3,943
T3	Veneer Tier 3	+7,474
HG __	High Gloss Polyester	+8,111

Step 4. Reveal Finish

MI __	Match Interior	+0
MC __	Powder Coat	+648
PM01	Polished Chrome	+648
PM02	Satin Nickel	+648
PM03	Oil Rubbed Bronze	+648

Step 5. Interior Finish

SL __	Satin Lacquer	+0
T1 __	Veneer Tier 1	+1,621
T2 __	Veneer Tier 2	+3,306
T3 __	Veneer Tier 3	+6,623
HG __	High Gloss Polyester	+7,120

Step 6. Door/Drawer Face Finish

SL __	Satin Lacquer	+0
T1 __	Veneer Tier 1	+797
T2 __	Veneer Tier 2	+1,632
T3 __	Veneer Tier 3	+3,264
HG __	High Gloss Polyester	+3,831

Step 7. Configuration

Specify Left to Right: Select single or double space components for 6 available positions. When any double space component is selected, insert code in desired starting position and XXXX in subsequent position.

03 _ _ _ _ C	Position 1
03 _ _ _ _ C	Position 2
03 _ _ _ _ C	Position 3
03 _ _ _ _ C	Position 4
03 _ _ _ _ C	Position 5
03 _ _ _ _ C	Position 6

DOUBLE SPACE COMPONENTS

03DR36C	Doors w/adjustable shelf	0
03FF36C	Drawer over Lateral File	342
03OF36C	Open over Lateral File	321
03DD36C	Drawer over Doors	417
03TP36C	Trash Pullout	1,059
03AV36C	2 Door AV	449

SINGLE SPACE COMPONENTS

03DR18C	Door w/adjustable shelf	0
03FF18C	Drawer over File	171
03OF85C	Open over File	161
03DD18C	Drawer over Door	209
03TP18C	Trash Pullout	530

Please consult **page 7** for the palette of DatesWeiser finishes. Natural stone, non-standard glass and veneer, and other technology options are available. Please email customerservice@datesweiser.com for a custom quote. Consult technical information on **page 319** for construction and technical details.