

Introduction	General Specification	2
	Materials & Finish Palette	7
Tables	Rectangular Conference Tables	10
	Media Tables	26
Credenza	Bookcase	44
	3 Position Credenzas	46
	4 Position Credenzas	50
	5 Position Credenzas	54
	Credenza Inserts	58
Alpha-Numeric Index		67
Selling Policy		70
General Ordering Information		73

Note:

Line drawings in this price list are purely for quick product identification without form of detail and cannot be used to satisfy production dimensions, shape or support options. Refer to Planning Guide for detailed product information.

Wood Components

Tops are 1-1/4" or 2" thick.

Bases are constructed using 3/4" thick material with mitered corners, in two widths (3-1/2" and 6") and two depths (24-1/2" and 30-1/2"). Bases also have a hinged access door for wire management.

Levelers

All bases are equipped with floor levelers to level the table.

Grommets

Please contact customer service at customerservice@datesweiser.com or your local DatesWeiser representative to request a quote based on your specific needs. To find your local representative, visit www.datesweiser.com/contacts.

Power & Connectivity

Mounted discretely around the perimeter of the table, power & connectivity is available in two versions (Fixed and Slide-Out) in both plug-in and hardwire connections to accommodate almost any need you may have. Wire management is easily handled vertically through the bases (via the hinged access door) and horizontally through the aprons.

Access door on 3-1/2" wide bases uses 3/4" finger-pull gap above the door to open.

Access door on 6" wide bases uses touch latch to open.

Wood Finishes and Materials

Selecting materials and other features are the first steps to ordering your DatesWeiser furniture. As you move through the steps on the product pages, you will need to fill in the blanks with the codes for the finishes and features you select.

Wood veneers are selected from the finest hardwoods available around the world and top coated with a low-VOC, post-catalyzed finish. The typical sheen is 30%.

Veneers come in three price ranges (Tiers), and described as follows:

1. Cut (Plain-sliced, rift, quartered, engineered)
2. Species (Oak, Walnut, etc.)
3. Finish (Natural, Smoked, Dark, Cerused, etc.)

Quartered, rift-cut and engineered veneers are slip matched except for Black Limba.

Plain-sliced veneers are book matched.

Examples:

1. T124 (Denotes Tier 1 Plain sliced Maple, Natural)
2. T227 (Denotes Tier 2 Quartered Walnut, Natural)

Requests for FSC certified materials must be made before an order can be processed.

Paint Finishes and Materials

SL__ (Satin Lacquer)

Opaque paint with a 50% typical sheen.

HG__ (High Gloss Polyester)

Opaque paint with a hand rubbed high gloss finish.

*Color codes are entered in the blanks.

Metal Finishes and Materials

MC__ Powder Coat

A coating applied electrostatically as a dry powder, then cured under heat to allow it to flow and form a "skin". Used to create a hard finish that is more durable than conventional paint.

PM__ Premium Metal

Electroplating produces a premium metal finish.

*Color codes entered in the blanks.

Finishing Excellence

DatesWeiser collaborates with leading colorists to develop a palette particularly suited to the executive workplace. This range is available on all our products and coordinates with our extensive veneer offering.

To order finish samples, please contact customer service at customerservice@datesweiser.com or your local DatesWeiser representative. To find your local DatesWeiser representative, visit www.datesweiser.com/contacts.

If you do not see what you want, we are happy to work with you to develop a unique product solution.

Datesweiser printed and veneer samples offer an example of what a typical veneer will look like, within a range of acceptability carefully determined by DatesWeiser. Samples and printed sample materials should be used as reference only.

FSC® Certification:**FSC-C103565**

Responsibility harvested materials certified by the Forest Stewardship Council® are available upon request and may increase pricing. Requests for FSC certified materials or LEED certification must be made before an order is processed.

Product Maintenance

Regular dusting with a soft cloth will help prevent fine dust particles from becoming embedded in the finished surface. We recommend using a soft flannel cloth slightly dampened with water, followed by a dry cloth. Always wipe in the direction of the grain.

CAUTION:

Never use a chemically treated cleaning cloth.

For removing residues, smudges, etc., we recommend using a very mild (non-ammonia) soap and water solution. Apply with a soft flannel cloth followed by a dry cloth. Always wipe in the direction of the grain.

We recommend using felt pads on all objects that come into contact with our furniture. Certain vinyl and rubber products can chemically react with the finish on wood if left in contact for extended periods of time. Coasters, place mats, notebook covers, and rubber or plastic feet (found on most accessories) can also damage wood surfaces. To avoid indentations caused by writing instruments, always use a non-vinyl blotter or writing pad.

All furniture should be used in a stable, controlled atmosphere and positioned to avoid direct sunlight. The ideal climate is 65-75°F with 30-55% relative humidity.

General Specification

Rectangular Conference Tables

Edge Profiles

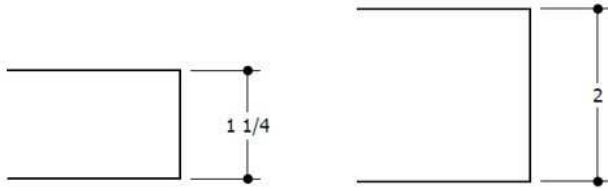
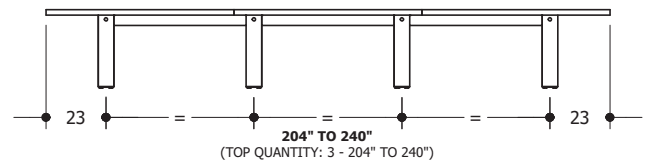
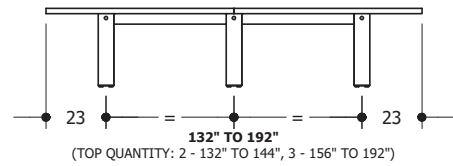
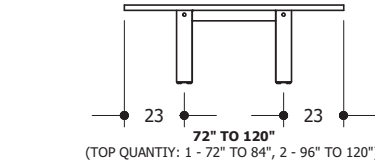
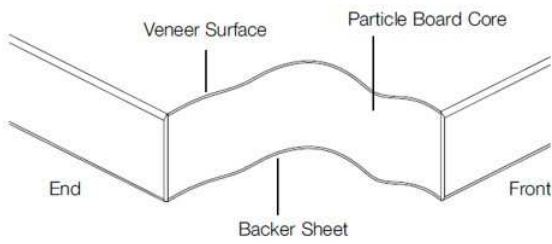

Table Construction



BASE QUANTITY BY TABLE LENGTH (48" & 60" DEEP)

Top Construction



Bases, 24-1/2" and 30-1/2" Deep with Hinged Door

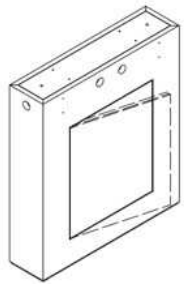

6" Wide Base

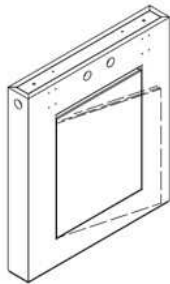

3-1/2" Wide Base

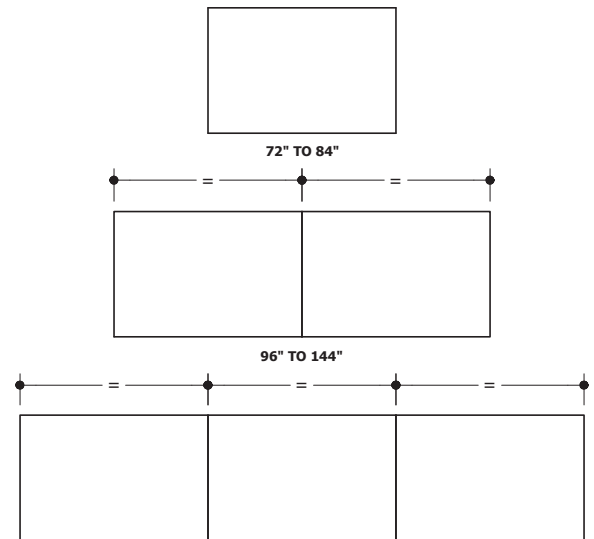

TOP QUANTITY BY TABLE LENGTH (48" & 60" DEEP)

Power and Connectivity

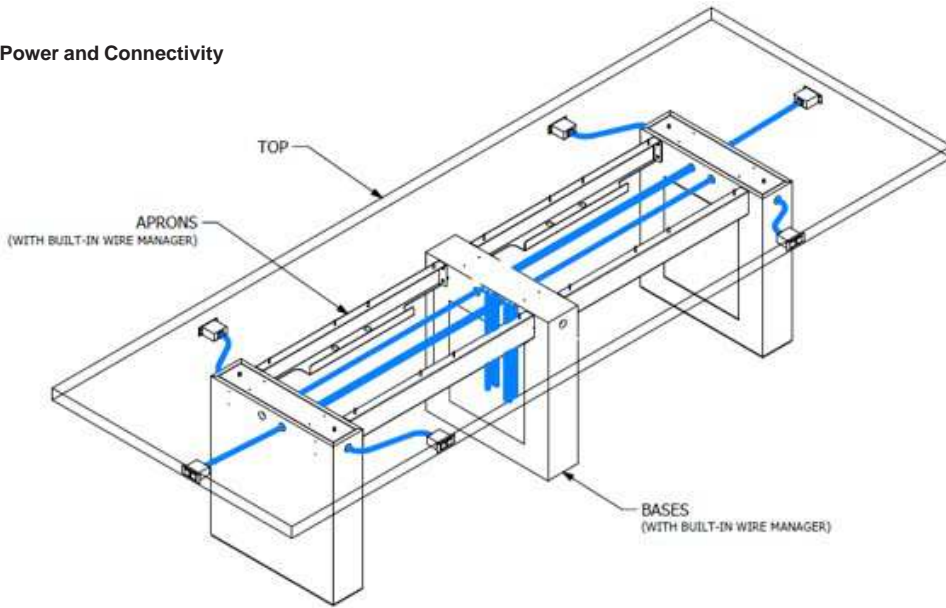

Wire Management

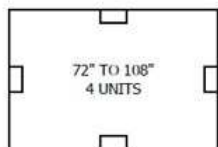
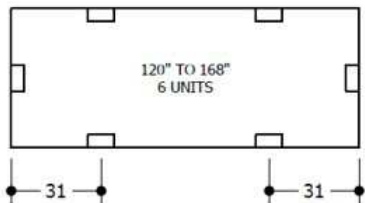
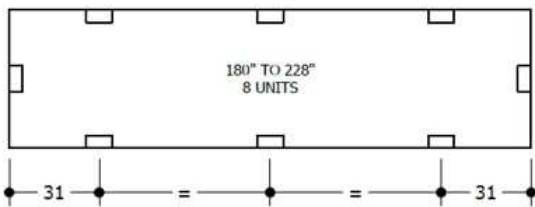
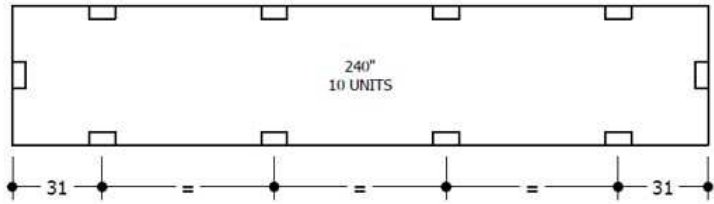

Undermount location And Quantities by length

Edge Profiles

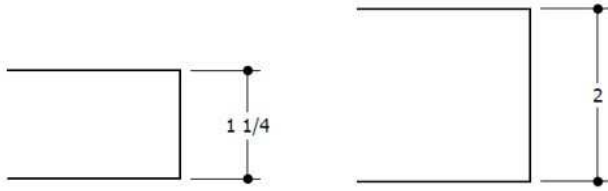

Partial Media Wall Table Construction

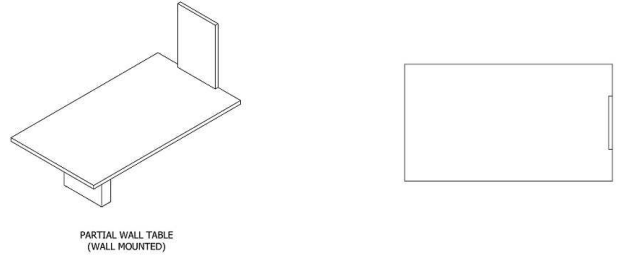

Top Construction

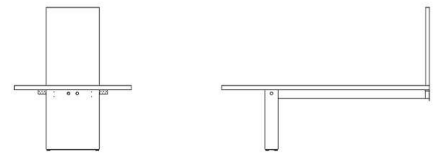
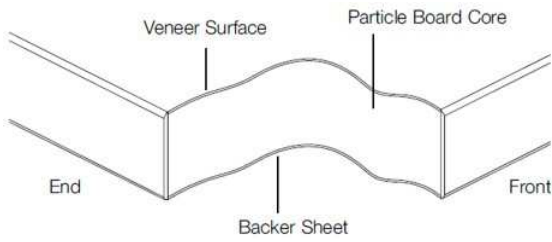

Architectural Wall Mounted Table Construction (no Media Wall)

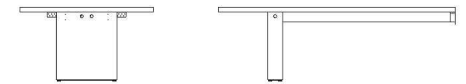
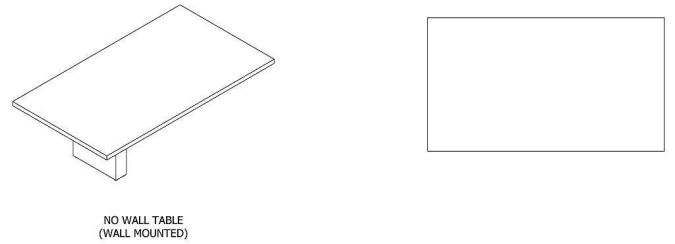

Bases, 24-1/2" and 30-1/2" Deep with Hinged Door

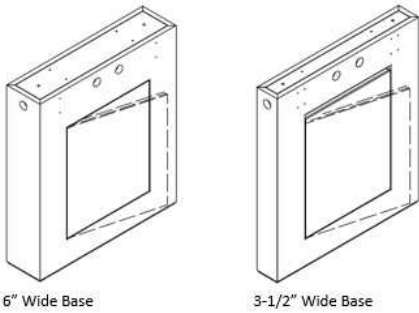

Full Media Wall Table Construction

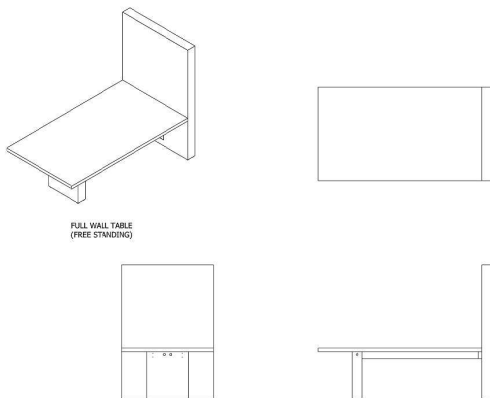
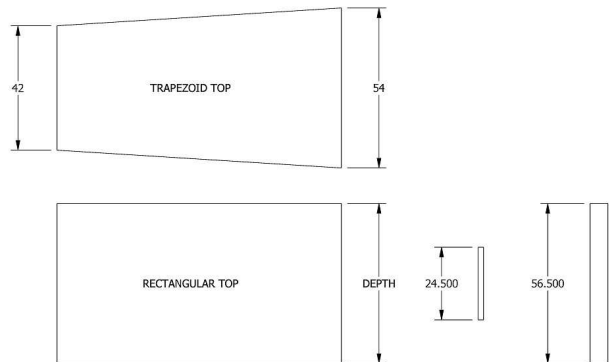
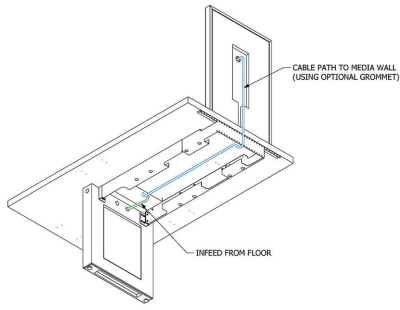

Table Construction



Power and Connectivity

Partial Wall Cable Planning



CABLING DIAGRAM:
WALL-MOUNTED TABLE AND PARTIAL MEDIA WALL
WITH TABLETOP POWER OPTION

Slide out power option

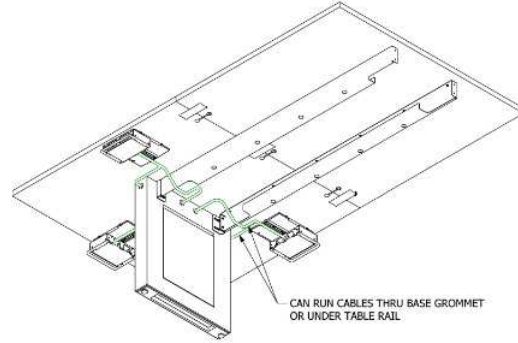

CABLING DIAGRAM:
SLIDE-OUT POWER OPTION

Full Wall Cable Planning

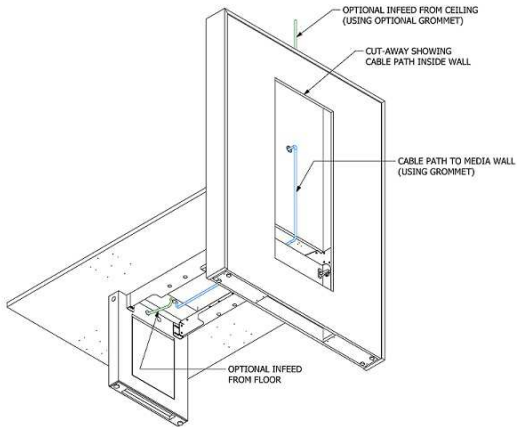

CABLING DIAGRAM:
FREE-STANDING TABLE AND FULL MEDIA WALL
WITH TABLETOP POWER OPTION

Under-mount power option

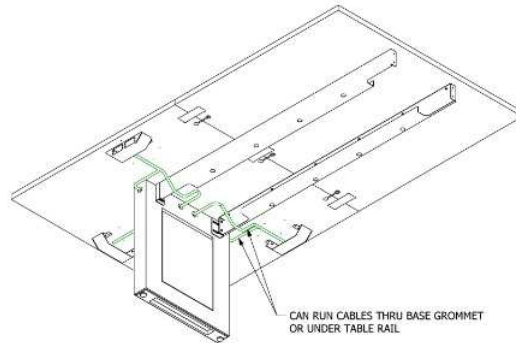

CABLING DIAGRAM:
UNDER-MOUNT POWER OPTION

Veneer: Tier 1

Applies to Tops & Bases



T102 Rift European White Oak, Natural



T142 Rift American White Oak, Natural



T105 Plain-sliced Walnut, Natural

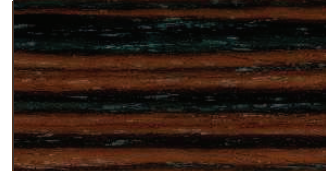

T131 Reconstituted Macassar Ebony, Natural

Veneer: Tier 2

Applies to Tops & Bases

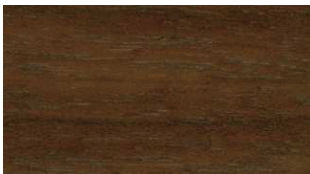

T206 Plain-sliced Walnut, Smoked



T227 Quartered Walnut, Natural



T228 Quartered Black Limba, Natural

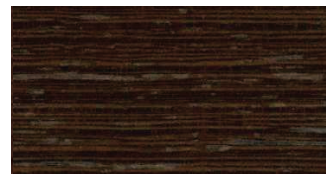

T229 Quartered Wenge, Natural

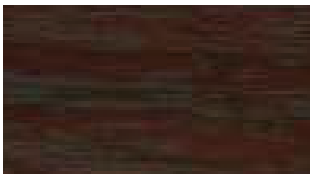

T207 Plain-sliced Walnut, Dark

Satin Lacquer

Applies to Bases Only



SL01 White



SL09 Black Brown



SL13 Jet Black



SL08 Umbra Grey

Rectangular Conference Tables

48" Deep Tops, 29 1/4" High

1 1/4" Thick Tops, 3 1/2" wide Bases

description	type	d	w	h	pattern no.
Tables with 3 1/2" wide Bases	1 (72") tops, 2 (3 1/2") bases	48"	72"	29 1/4"	07R48X72V13
	1 (84") tops, 2 (3 1/2") bases	48"	84"	29 1/4"	07R48X84V13
	2 (48") tops, 2 (3 1/2") bases	48"	96"	29 1/4"	07R48X96V13
	2 (54") tops, 2 (3 1/2") bases	48"	108"	29 1/4"	07R48X108V13
	2 (60") tops, 2 (3 1/2") bases	48"	120"	29 1/4"	07R48X120V13
	2 (66") tops, 3 (3 1/2") bases	48"	132"	29 1/4"	07R48X132V13
	2 (72") tops, 3 (3 1/2") bases	48"	144"	29 1/4"	07R48X144V13
	3 (52") tops, 3 (3 1/2") bases	48"	156"	29 1/4"	07R48X156V13
	3 (56") tops, 3 (3 1/2") bases	48"	168"	29 1/4"	07R48X168V13
	3 (60") tops, 3 (3 1/2") bases	48"	180"	29 1/4"	07R48X180V13
	3 (64") tops, 3 (3 1/2") bases	48"	192"	29 1/4"	07R48X192V13
	3 (68") tops, 4 (3 1/2") bases	48"	204"	29 1/4"	07R48X204V13
	3 (72") tops, 4 (3 1/2") bases	48"	216"	29 1/4"	07R48X216V13
	3 (76") tops, 4 (3 1/2") bases	48"	228"	29 1/4"	07R48X228V13
	3 (80") tops, 4 (3 1/2") bases	48"	240"	29 1/4"	07R48X240V13

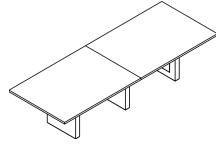

T1P	T2P	T1 upcharge	T2 upcharge	UMHW upcharge	UMPI upcharge	UMLK upcharge	SOHW upcharge	SOPI upcharge	SOLK upcharge
\$7,992.	\$8,337.	\$890.	\$1,243.	\$4,788.	\$3,480.	\$3,480.	\$8,341.	\$7,076.	\$7,076.
8,490.	8,891.	890.	1,243.	4,788.	3,480.	3,480.	8,341.	7,076.	7,076.
8,961.	9,420.	890.	1,243.	4,788.	3,480.	3,480.	8,341.	7,076.	7,076.
9,516.	10,043.	890.	1,243.	4,788.	3,480.	3,480.	8,341.	7,076.	7,076.
9,991.	10,567.	890.	1,243.	7,182.	5,221.	5,221.	12,512.	10,614.	10,614.
12,316.	12,955.	1,337.	1,864.	7,182.	5,221.	5,221.	12,512.	10,614.	10,614.
12,831.	13,521.	1,337.	1,864.	7,182.	5,221.	5,221.	12,512.	10,614.	10,614.
13,323.	14,069.	1,337.	1,864.	7,182.	5,221.	5,221.	12,512.	10,614.	10,614.
13,818.	14,621.	1,337.	1,864.	7,182.	5,221.	5,221.	12,512.	10,614.	10,614.
14,314.	15,178.	1,337.	1,864.	9,576.	6,961.	6,961.	16,682.	14,152.	14,152.
15,226.	16,158.	1,337.	1,864.	9,576.	6,961.	6,961.	16,682.	14,152.	14,152.
17,170.	18,139.	1,782.	2,484.	9,576.	6,961.	6,961.	16,682.	14,152.	14,152.
17,655.	18,698.	1,782.	2,484.	9,576.	6,961.	6,961.	16,682.	14,152.	14,152.
18,163.	19,243.	1,782.	2,484.	9,576.	6,961.	6,961.	16,682.	14,152.	14,152.
18,651.	19,805.	1,782.	2,484.	11,971.	8,701.	8,701.	20,853.	17,690.	17,690.

Order Code	Specification Information	Pricing Tiers
Example: 07R48X72V13	<i>To order please specify pattern number including:</i>	T1P = Tier 1 veneer top with painted base
07 JD Collection	1. Top finish: ()	T2P = Tier 2 veneer top with painted bases
R Rectangular Conference Table	2. Base finish: ()	T1 = Upcharge from T1P for Tier 1 veneer bases
48X Depth	3. Power and connectivity (Optional, blank for none):	T2 = Upcharge from T2P for Tier 2 veneer bases
72 Width	UMHW Under-mount, Hardwire	
V Veneer	UMPI Under-mount, Plug in	
1 1 1/4" thick top	UMLK Under-mount, Linkable	
3 3 1/2" wide Base	SOHW Slide out, Hardwired	
	SOPI Slide out, Plug in	
	SOLK Slide-out, Linkable	

Please refer to Materials and Finishes page 7 for specification details.

Application Notes
Tables ship knocked-down, assembly required.
Tables come with structural metal aprons, finished in metallic black powder (MC12).
Wire management handled vertically through bases and horizontally through aprons.
Bases can fully or partially conceal a floor core, pending the application. This ability will vary based on type, size, location of the floor core.
Finish and grain matched on tables with multi-piece tops
Undermount power units finished in metallic black powder (MC12).
Tops pre-drilled for installation of undermount power.
Undermount power unit comes with (x1) dual AC hardwire (HW) or plug in(PI) power module and (x2) single space blank plates. For additional connectivity, replace blank plates with Extron single or double space AAP modules as desired. For more information see extron.com .

Rectangular Conference Tables

48" Deep Tops, 29 1/4" High

1 1/4" Thick Tops, 6" wide Bases

description	type	d	w	h	pattern no.
Tables with 6" wide Bases	1 (72") tops, 2 (6") bases	48"	72"	29 1/4"	07R48X72V16
	1 (84") tops, 2 (6") bases	48"	84"	29 1/4"	07R48X84V16
	2 (48") tops, 2 (6") bases	48"	96"	29 1/4"	07R48X96V16
	2 (54") tops, 2 (6") bases	48"	108"	29 1/4"	07R48X108V16
	2 (60") tops, 2 (6") bases	48"	120"	29 1/4"	07R48X120V16
	2 (66") tops, 3 (6") bases	48"	132"	29 1/4"	07R48X132V16
	2 (72") tops, 3 (6") bases	48"	144"	29 1/4"	07R48X144V16
	3 (52") tops, 3 (6") bases	48"	156"	29 1/4"	07R48X156V16
	3 (56") tops, 3 (6") bases	48"	168"	29 1/4"	07R48X168V16
	3 (60") tops, 3 (6") bases	48"	180"	29 1/4"	07R48X180V16
	3 (64") tops, 3 (6") bases	48"	192"	29 1/4"	07R48X192V16
	3 (68") tops, 4 (6") bases	48"	204"	29 1/4"	07R48X204V16
	3 (72") tops, 4 (6") bases	48"	216"	29 1/4"	07R48X216V16
	3 (76") tops, 4 (6") bases	48"	228"	29 1/4"	07R48X228V16
	3 (80") tops, 4 (6") bases	48"	240"	29 1/4"	07R48X240V16

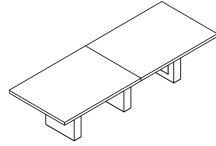

T1P	T2P	T1 upcharge	T2 upcharge	UMHW upcharge	UMPI upcharge	UMLK upcharge	SOHW upcharge	SOPI upcharge	SOLK upcharge
\$8,110.	\$8,466.	\$890.	\$1,243.	\$4,788.	\$3,480.	\$3,480.	\$8,341.	\$7,076.	\$7,076.
8,620.	9,022.	890.	1,243.	4,788.	3,480.	3,480.	8,341.	7,076.	7,076.
9,115.	9,573.	890.	1,243.	4,788.	3,480.	3,480.	8,341.	7,076.	7,076.
9,613.	10,133.	890.	1,243.	4,788.	3,480.	3,480.	8,341.	7,076.	7,076.
10,119.	10,686.	890.	1,243.	7,182.	5,221.	5,221.	12,512.	10,614.	10,614.
12,521.	13,170.	1,337.	1,864.	7,182.	5,221.	5,221.	12,512.	10,614.	10,614.
13,017.	13,707.	1,337.	1,864.	7,182.	5,221.	5,221.	12,512.	10,614.	10,614.
13,527.	14,272.	1,337.	1,864.	7,182.	5,221.	5,221.	12,512.	10,614.	10,614.
14,018.	14,839.	1,337.	1,864.	7,182.	5,221.	5,221.	12,512.	10,614.	10,614.
14,524.	15,380.	1,337.	1,864.	9,576.	6,961.	6,961.	16,682.	14,152.	14,152.
15,423.	16,357.	1,337.	1,864.	9,576.	6,961.	6,961.	16,682.	14,152.	14,152.
17,433.	18,403.	1,782.	2,484.	9,576.	6,961.	6,961.	16,682.	14,152.	14,152.
17,915.	18,962.	1,782.	2,484.	9,576.	6,961.	6,961.	16,682.	14,152.	14,152.
18,426.	19,519.	1,782.	2,484.	9,576.	6,961.	6,961.	16,682.	14,152.	14,152.
18,923.	20,083.	1,782.	2,484.	11,971.	8,701.	8,701.	20,853.	17,690.	17,690.

Order Code	Specification Information	Pricing Tiers
Example: 07R48X72V16	<i>To order please specify pattern number including:</i>	T1P = Tier 1 veneer top with painted base
07 JD Collection	1. Top finish: ()	T2P = Tier 2 veneer top with painted bases
R Rectangular Conference Table	2. Base finish: ()	T1 = Upcharge from T1P for Tier 1 veneer bases
48X Depth	3. Power and connectivity (Optional, blank for none):	T2 = Upcharge from T2P for Tier 2 veneer bases
72 Width	UMHW Under-mount, Hardwire	
V Veneer	UMPI Under-mount, Plug in	
1 1 1/4" thick top	UMLK Under-mount, Linkable	
6 6" wide Base	SOHW Slide out, Hardwired	
	SOPI Slide out, Plug in	
	SOLK Slide-out, Linkable	

Please refer to Materials and Finishes page 7 for specification details.

Application Notes
Tables ship knocked-down, assembly required.
Tables come with structural metal aprons, finished in metallic black powder (MC12).
Wire management handled vertically through bases and horizontally through aprons.
Bases can fully or partially conceal a floor core, pending the application. This ability will vary based on type, size, location of the floor core.
Finish and grain matched on tables with multi-piece tops
Undermount power units finished in metallic black powder (MC12).
Tops pre-drilled for installation of undermount power.
Undermount power unit comes with (x1) dual AC hardwire (HW) or plug in(PI) power module and (x2) single space blank plates. For additional connectivity, replace blank plates with Extron single or double space AAP modules as desired. For more information see extron.com .

Rectangular Conference Tables

48" Deep Tops, 29 1/4" High
2" Thick Tops, 3 1/2" wide Bases

description	type	d	w	h	pattern no.
Tables with 3 1/2" wide Bases	1 (72") tops, 2 (3 1/2") bases	48"	72"	29 1/4"	07R48X72V23
	1 (84") tops, 2 (3 1/2") bases	48"	84"	29 1/4"	07R48X84V23
	2 (48") tops, 2 (3 1/2") bases	48"	96"	29 1/4"	07R48X96V23
	2 (54") tops, 2 (3 1/2") bases	48"	108"	29 1/4"	07R48X108V23
	2 (60") tops, 2 (3 1/2") bases	48"	120"	29 1/4"	07R48X120V23
	2 (66") tops, 3 (3 1/2") bases	48"	132"	29 1/4"	07R48X132V23
	2 (72") tops, 3 (3 1/2") bases	48"	144"	29 1/4"	07R48X144V23
	3 (52") tops, 3 (3 1/2") bases	48"	156"	29 1/4"	07R48X156V23
	3 (56") tops, 3 (3 1/2") bases	48"	168"	29 1/4"	07R48X168V23
	3 (60") tops, 3 (3 1/2") bases	48"	180"	29 1/4"	07R48X180V23
	3 (64") tops, 3 (3 1/2") bases	48"	192"	29 1/4"	07R48X192V23
	3 (68") tops, 4 (3 1/2") bases	48"	204"	29 1/4"	07R48X204V23
	3 (72") tops, 4 (3 1/2") bases	48"	216"	29 1/4"	07R48X216V23
	3 (76") tops, 4 (3 1/2") bases	48"	228"	29 1/4"	07R48X228V23
	3 (80") tops, 4 (3 1/2") bases	48"	240"	29 1/4"	07R48X240V23

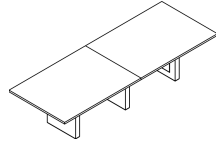

T1P	T2P	T1 upcharge	T2 upcharge	UMHW upcharge	UMPI upcharge	UMLK upcharge	SOHW upcharge	SOPI upcharge	SOLK upcharge
\$8,284.	\$8,629.	\$890.	\$1,243.	\$4,788.	\$3,480.	\$3,480.	\$8,341.	\$7,076.	\$7,076.
8,825.	9,230.	890.	1,243.	4,788.	3,480.	3,480.	8,341.	7,076.	7,076.
9,355.	9,815.	890.	1,243.	4,788.	3,480.	3,480.	8,341.	7,076.	7,076.
9,959.	10,485.	890.	1,243.	4,788.	3,480.	3,480.	8,341.	7,076.	7,076.
10,470.	11,050.	890.	1,243.	7,182.	5,221.	5,221.	12,512.	10,614.	10,614.
12,862.	13,503.	1,337.	1,864.	7,182.	5,221.	5,221.	12,512.	10,614.	10,614.
13,406.	14,111.	1,337.	1,864.	7,182.	5,221.	5,221.	12,512.	10,614.	10,614.
13,960.	14,716.	1,337.	1,864.	7,182.	5,221.	5,221.	12,512.	10,614.	10,614.
14,513.	15,307.	1,337.	1,864.	7,182.	5,221.	5,221.	12,512.	10,614.	10,614.
15,074.	15,916.	1,337.	1,864.	9,576.	6,961.	6,961.	16,682.	14,152.	14,152.
16,017.	16,944.	1,337.	1,864.	9,576.	6,961.	6,961.	16,682.	14,152.	14,152.
18,002.	18,988.	1,782.	2,484.	9,576.	6,961.	6,961.	16,682.	14,152.	14,152.
18,548.	19,263.	1,782.	2,484.	9,576.	6,961.	6,961.	16,682.	14,152.	14,152.
19,102.	19,867.	1,782.	2,484.	9,576.	6,961.	6,961.	16,682.	14,152.	14,152.
19,650.	20,463.	1,782.	2,484.	11,971.	8,701.	8,701.	20,853.	17,690.	17,690.

Order Code	Specification Information	Pricing Tiers
Example: 07R48X72V23	<i>To order please specify pattern number including:</i>	T1P = Tier 1 veneer top with painted base
07 JD Collection	1. Top finish: ()	T2P = Tier 2 veneer top with painted bases
R Rectangular Conference Table	2. Base finish: ()	T1 = Upcharge from T1P for Tier 1 veneer bases
48X Depth	3. Power and connectivity (Optional, blank for none):	T2 = Upcharge from T2P for Tier 2 veneer bases
72 Width	UMHW Under-mount, Hardwire	
V Veneer	UMPI Under-mount, Plug in	
2 2" thick top	UMLK Under-mount, Linkable	
3 3 1/2" wide Base	SOHW Slide out, Hardwired	
	SOPI Slide out, Plug in	
	SOLK Slide-out, Linkable	

Please refer to Materials and Finishes page 7 for specification details.

Application Notes
Tables ship knocked-down, assembly required.
Tables come with structural metal aprons, finished in metallic black powder (MC12).
Wire management handled vertically through bases and horizontally through aprons.
Bases can fully or partially conceal a floor core, pending the application. This ability will vary based on type, size, location of the floor core.
Finish and grain matched on tables with multi-piece tops
Undermount power units finished in metallic black powder (MC12).
Tops pre-drilled for installation of undermount power.
Undermount power unit comes with (x1) dual AC hardwire (HW) or plug in(PI) power module and (x2) single space blank plates. For additional connectivity, replace blank plates with Extron single or double space AAP modules as desired. For more information see extron.com .

Rectangular Conference Tables

48" Deep Tops, 29 1/4" High

2" Thick Tops, 6" wide Bases

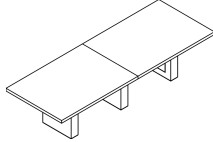
description	type	d	w	h	pattern no.
Tables with 6" wide Bases 	1 (72") tops, 2 (6") bases	48"	72"	29 1/4"	07R48X72V26
	1 (84") tops, 2 (6") bases	48"	84"	29 1/4"	07R48X84V26
	2 (48") tops, 2 (6") bases	48"	96"	29 1/4"	07R48X96V26
	2 (54") tops, 2 (6") bases	48"	108"	29 1/4"	07R48X108V26
	2 (60") tops, 2 (6") bases	48"	120"	29 1/4"	07R48X120V26
	2 (66") tops, 3 (6") bases	48"	132"	29 1/4"	07R48X132V26
	2 (72") tops, 3 (6") bases	48"	144"	29 1/4"	07R48X144V26
	3 (52") tops, 3 (6") bases	48"	156"	29 1/4"	07R48X156V26
	3 (56") tops, 3 (6") bases	48"	168"	29 1/4"	07R48X168V26
	3 (60") tops, 3 (6") bases	48"	180"	29 1/4"	07R48X180V26
	3 (64") tops, 3 (6") bases	48"	192"	29 1/4"	07R48X192V26
	3 (68") tops, 4 (6") bases	48"	204"	29 1/4"	07R48X204V26
	3 (72") tops, 4 (6") bases	48"	216"	29 1/4"	07R48X216V26
	3 (76") tops, 4 (6") bases	48"	228"	29 1/4"	07R48X228V26
	3 (80") tops, 4 (6") bases	48"	240"	29 1/4"	07R48X240V26

T1P	T2P	T1 upcharge	T2 upcharge	UMHW upcharge	UMPI upcharge	UMLK upcharge	SOHW upcharge	SOPI upcharge	SOLK upcharge
\$8,408.	\$8,753.	\$890.	\$1,243.	\$4,788.	\$3,480.	\$3,480.	\$8,341.	\$7,076.	\$7,076.
8,958.	9,372.	890.	1,243.	4,788.	3,480.	3,480.	8,341.	7,076.	7,076.
9,515.	9,978.	890.	1,243.	4,788.	3,480.	3,480.	8,341.	7,076.	7,076.
10,063.	10,569.	890.	1,243.	4,788.	3,480.	3,480.	8,341.	7,076.	7,076.
10,612.	11,179.	890.	1,243.	7,182.	5,221.	5,221.	12,512.	10,614.	10,614.
13,062.	13,696.	1,337.	1,864.	7,182.	5,221.	5,221.	12,512.	10,614.	10,614.
13,622.	14,299.	1,337.	1,864.	7,182.	5,221.	5,221.	12,512.	10,614.	10,614.
14,155.	14,913.	1,337.	1,864.	7,182.	5,221.	5,221.	12,512.	10,614.	10,614.
14,709.	15,518.	1,337.	1,864.	7,182.	5,221.	5,221.	12,512.	10,614.	10,614.
15,259.	16,117.	1,337.	1,864.	9,576.	6,961.	6,961.	16,682.	14,152.	14,152.
17,434.	17,149.	1,337.	1,864.	9,576.	6,961.	6,961.	16,682.	14,152.	14,152.
18,274.	19,236.	1,782.	2,484.	9,576.	6,961.	6,961.	16,682.	14,152.	14,152.
18,821.	19,854.	1,782.	2,484.	9,576.	6,961.	6,961.	16,682.	14,152.	14,152.
19,366.	20,442.	1,782.	2,484.	9,576.	6,961.	6,961.	16,682.	14,152.	14,152.
19,918.	21,064.	1,782.	2,484.	11,971.	8,701.	8,701.	20,853.	17,690.	17,690.

Order Code	Specification Information	Pricing Tiers
Example: 07R48X72V26 07 JD Collection R Rectangular Conference Table 48X Depth 72 Width V Veneer 2 2" thick top 6 6" wide Base	To order please specify pattern number including: 1. Top finish: () 2. Base finish: () 3. Power and connectivity (Optional, blank for none): UMHW Under-mount, Hardwire UMPI Under-mount, Plug in UMLK Under-mount, Linkable SOHW Slide out, Hardwired SOPI Slide out, Plug in SOLK Slide-out, Linkable	T1P = Tier 1 veneer top with painted base T2P = Tier 2 veneer top with painted bases T1 = Upcharge from T1P for Tier 1 veneer bases T2 = Upcharge from T2P for Tier 2 veneer bases

Please refer to Materials and Finishes page 7 for specification details.

Application Notes	
Tables ship knocked-down, assembly required. Tables come with structural metal aprons, finished in metallic black powder (MC12). Wire management handled vertically through bases and horizontally through aprons. Bases can fully or partially conceal a floor core, pending the application. This ability will vary based on type, size, location of the floor core.	Finish and grain matched on tables with multi-piece tops Undermount power units finished in metallic black powder (MC12). Tops pre-drilled for installation of undermount power. Undermount power unit comes with (x1) dual AC hardwire (HW) or plug in(PI) power module and (x2) single space blank plates. For additional connectivity, replace blank plates with Extron single or double space AAP modules as desired. For more information see extron.com .

Rectangular Conference Tables

60" Deep Tops, 29 1/4" High
1 1/4" Thick Tops, 3 1/2" wide Bases

description	type	d	w	h	pattern no.
Tables with 3 1/2" wide Bases	1 (72") tops, 2 (3 1/2") bases	60"	72"	29 1/4"	07R60X72V13
	1 (84") tops, 2 (3 1/2") bases	60"	84"	29 1/4"	07R60X84V13
	2 (48") tops, 2 (3 1/2") bases	60"	96"	29 1/4"	07R60X96V13
	2 (54") tops, 2 (3 1/2") bases	60"	108"	29 1/4"	07R60X108V13
	2 (60") tops, 2 (3 1/2") bases	60"	120"	29 1/4"	07R60X120V13
	2 (66") tops, 3 (3 1/2") bases	60"	132"	29 1/4"	07R60X132V13
	2 (72") tops, 3 (3 1/2") bases	60"	144"	29 1/4"	07R60X144V13
	3 (52") tops, 3 (3 1/2") bases	60"	156"	29 1/4"	07R60X156V13
	3 (56") tops, 3 (3 1/2") bases	60"	168"	29 1/4"	07R60X168V13
	3 (60") tops, 3 (3 1/2") bases	60"	180"	29 1/4"	07R60X180V13
	3 (64") tops, 3 (3 1/2") bases	60"	192"	29 1/4"	07R60X192V13
	3 (68") tops, 4 (3 1/2") bases	60"	204"	29 1/4"	07R60X204V13
	3 (72") tops, 4 (3 1/2") bases	60"	216"	29 1/4"	07R60X216V13
	3 (76") tops, 4 (3 1/2") bases	60"	228"	29 1/4"	07R60X228V13
	3 (80") tops, 4 (3 1/2") bases	60"	240"	29 1/4"	07R60X240V13

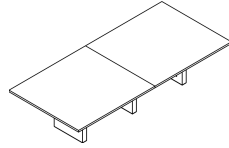

T1P	T2P	T1 upcharge	T2 upcharge	UMHW upcharge	UMPI upcharge	UMLK upcharge	SOHW upcharge	SOPI upcharge	SOLK upcharge
\$8,715.	\$9,149.	\$911.	\$1,267.	\$4,788.	\$3,480.	\$3,480.	\$8,341.	\$7,076.	\$7,076.
9,332.	9,849.	911.	1,267.	4,788.	3,480.	3,480.	8,341.	7,076.	7,076.
9,957.	10,534.	911.	1,267.	4,788.	3,480.	3,480.	8,341.	7,076.	7,076.
10,573.	11,222.	911.	1,267.	4,788.	3,480.	3,480.	8,341.	7,076.	7,076.
11,190.	11,923.	911.	1,267.	7,182.	5,221.	5,221.	12,512.	10,614.	10,614.
13,664.	14,452.	1,380.	1,913.	7,182.	5,221.	5,221.	12,512.	10,614.	10,614.
14,272.	15,144.	1,380.	1,913.	7,182.	5,221.	5,221.	12,512.	10,614.	10,614.
14,890.	15,820.	1,380.	1,913.	7,182.	5,221.	5,221.	12,512.	10,614.	10,614.
15,518.	16,518.	1,380.	1,913.	7,182.	5,221.	5,221.	12,512.	10,614.	10,614.
16,129.	17,219.	1,380.	1,913.	9,576.	6,961.	6,961.	16,682.	14,152.	14,152.
17,167.	18,305.	1,380.	1,913.	9,576.	6,961.	6,961.	16,682.	14,152.	14,152.
19,223.	20,437.	1,820.	2,534.	9,576.	6,961.	6,961.	16,682.	14,152.	14,152.
19,819.	21,122.	1,820.	2,534.	9,576.	6,961.	6,961.	16,682.	14,152.	14,152.
20,204.	21,569.	1,820.	2,534.	9,576.	6,961.	6,961.	16,682.	14,152.	14,152.
21,052.	22,508.	1,820.	2,534.	11,971.	8,701.	8,701.	20,853.	17,690.	17,690.

Order Code	Specification Information	Pricing Tiers
Example: 07R60X72V13	<i>To order please specify pattern number including:</i>	T1P = Tier 1 veneer top with painted base
07 JD Collection	1. Top finish: ()	T2P = Tier 2 veneer top with painted bases
R Rectangular Conference Table	2. Base finish: ()	T1 = Upcharge from T1P for Tier 1 veneer bases
60X Depth	3. Power and connectivity (Optional, blank for none):	T2 = Upcharge from T2P for Tier 2 veneer bases
72 Width	UMHW Under-mount, Hardwire	
V Veneer	UMPI Under-mount, Plug in	
1 1 1/4" thick top	UMLK Under-mount, Linkable	
3 3 1/2" wide Base	SOHW Slide out, Hardwired	
	SOPI Slide out, Plug in	
	SOLK Slide-out, Linkable	

Please refer to Materials and Finishes page 7 for specification details.

Application Notes
Tables ship knocked-down, assembly required.
Tables come with structural metal aprons, finished in metallic black powder (MC12).
Wire management handled vertically through bases and horizontally through aprons.
Bases can fully or partially conceal a floor core, pending the application. This ability will vary based on type, size, location of the floor core.
Finish and grain matched on tables with multi-piece tops
Undermount power units finished in metallic black powder (MC12).
Tops pre-drilled for installation of undermount power.
Undermount power unit comes with (x1) dual AC hardwire (HW) or plug in(PI) power module and (x2) single space blank plates. For additional connectivity, replace blank plates with Extron single or double space AAP modules as desired. For more information see extron.com .

Rectangular Conference Tables

60" Deep Tops, 29 1/4" High

1 1/4" Thick Tops, 6" wide Bases

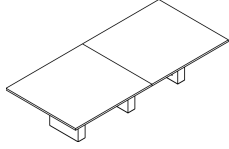
description	type	d	w	h	pattern no.
Tables with 6" wide Bases 	1 (72") tops, 2 (6") bases	60"	72"	29 1/4"	07R60X72V16
	1 (84") tops, 2 (6") bases	60"	84"	29 1/4"	07R60X84V16
	2 (48") tops, 2 (6") bases	60"	96"	29 1/4"	07R60X96V16
	2 (54") tops, 2 (6") bases	60"	108"	29 1/4"	07R60X108V16
	2 (60") tops, 2 (6") bases	60"	120"	29 1/4"	07R60X120V16
	2 (66") tops, 3 (6") bases	60"	132"	29 1/4"	07R60X132V16
	2 (72") tops, 3 (6") bases	60"	144"	29 1/4"	07R60X144V16
	3 (52") tops, 3 (6") bases	60"	156"	29 1/4"	07R60X156V16
	3 (56") tops, 3 (6") bases	60"	168"	29 1/4"	07R60X168V16
	3 (60") tops, 3 (6") bases	60"	180"	29 1/4"	07R60X180V16
	3 (64") tops, 3 (6") bases	60"	192"	29 1/4"	07R60X192V16
	3 (68") tops, 4 (6") bases	60"	204"	29 1/4"	07R60X204V16
	3 (72") tops, 4 (6") bases	60"	216"	29 1/4"	07R60X216V16
	3 (76") tops, 4 (6") bases	60"	228"	29 1/4"	07R60X228V16
	3 (80") tops, 4 (6") bases	60"	240"	29 1/4"	07R60X240V16

T1P	T2P	T1 upcharge	T2 upcharge	UMHW upcharge	UMPI upcharge	UMLK upcharge	SOHW upcharge	SOPI upcharge	SOLK upcharge
\$8,784.	\$9,211.	\$911.	\$1,267.	\$4,788.	\$3,480.	\$3,480.	\$8,341.	\$7,076.	\$7,076.
9,390.	9,900.	911.	1,267.	4,788.	3,480.	3,480.	8,341.	7,076.	7,076.
10,007.	10,585.	911.	1,267.	4,788.	3,480.	3,480.	8,341.	7,076.	7,076.
10,634.	11,284.	911.	1,267.	4,788.	3,480.	3,480.	8,341.	7,076.	7,076.
11,257.	11,975.	911.	1,267.	7,182.	5,221.	5,221.	12,512.	10,614.	10,614.
13,745.	14,523.	1,380.	1,913.	7,182.	5,221.	5,221.	12,512.	10,614.	10,614.
14,360.	15,231.	1,380.	1,913.	7,182.	5,221.	5,221.	12,512.	10,614.	10,614.
14,985.	15,907.	1,380.	1,913.	7,182.	5,221.	5,221.	12,512.	10,614.	10,614.
15,591.	16,590.	1,380.	1,913.	7,182.	5,221.	5,221.	12,512.	10,614.	10,614.
16,220.	17,289.	1,380.	1,913.	9,576.	6,961.	6,961.	16,682.	14,152.	14,152.
17,242.	18,394.	1,380.	1,913.	9,576.	6,961.	6,961.	16,682.	14,152.	14,152.
19,317.	20,531.	1,820.	2,534.	9,576.	6,961.	6,961.	16,682.	14,152.	14,152.
19,945.	21,220.	1,820.	2,534.	9,576.	6,961.	6,961.	16,682.	14,152.	14,152.
20,329.	21,696.	1,820.	2,534.	9,576.	6,961.	6,961.	16,682.	14,152.	14,152.
21,182.	22,610.	1,820.	2,534.	11,971.	8,701.	8,701.	20,853.	17,690.	17,690.

Order Code	Specification Information	Pricing Tiers
Example: 07R60X72V16 07 JD Collection R Rectangular Conference Table 60X Depth 72 Width V Veneer 1 1 1/4" thick top 6 6" wide Base	To order please specify pattern number including: 1. Top finish: () 2. Base finish: () 3. Power and connectivity (Optional, blank for none): UMHW Under-mount, Hardwire UMPI Under-mount, Plug in UMLK Under-mount, Linkable SOHW Slide out, Hardwired SOPI Slide out, Plug in SOLK Slide-out, Linkable	T1P = Tier 1 veneer top with painted base T2P = Tier 2 veneer top with painted bases T1 = Upcharge from T1P for Tier 1 veneer bases T2 = Upcharge from T2P for Tier 2 veneer bases

Please refer to Materials and Finishes page 7 for specification details.

Application Notes	
Tables ship knocked-down, assembly required. Tables come with structural metal aprons, finished in metallic black powder (MC12). Wire management handled vertically through bases and horizontally through aprons. Bases can fully or partially conceal a floor core, pending the application. This ability will vary based on type, size, location of the floor core.	Finish and grain matched on tables with multi-piece tops Undermount power units finished in metallic black powder (MC12). Tops pre-drilled for installation of undermount power. Undermount power unit comes with (x1) dual AC hardwire (HW) or plug in(PI) power module and (x2) single space blank plates. For additional connectivity, replace blank plates with Extron single or double space AAP modules as desired. For more information see extron.com .

Rectangular Conference Tables

60" Deep Tops, 29 1/4" High
2" Thick Tops, 3 1/2" wide Bases

description	t	d	w	h	pattern no.
Tables with 3 1/2" wide Bases	1 (72") tops, 2 (3 1/2") bases	60"	72"	29 1/4"	07R60X72V23
	1 (84") tops, 2 (3 1/2") bases	60"	84"	29 1/4"	07R60X84V23
	2 (48") tops, 2 (3 1/2") bases	60"	96"	29 1/4"	07R60X96V23
	2 (54") tops, 2 (3 1/2") bases	60"	108"	29 1/4"	07R60X108V23
	2 (60") tops, 2 (3 1/2") bases	60"	120"	29 1/4"	07R60X120V23
	2 (66") tops, 3 (3 1/2") bases	60"	132"	29 1/4"	07R60X132V23
	2 (72") tops, 3 (3 1/2") bases	60"	144"	29 1/4"	07R60X144V23
	3 (52") tops, 3 (3 1/2") bases	60"	156"	29 1/4"	07R60X156V23
	3 (56") tops, 3 (3 1/2") bases	60"	168"	29 1/4"	07R60X168V23
	3 (60") tops, 3 (3 1/2") bases	60"	180"	29 1/4"	07R60X180V23
	3 (64") tops, 3 (3 1/2") bases	60"	192"	29 1/4"	07R60X192V23
	3 (68") tops, 4 (3 1/2") bases	60"	204"	29 1/4"	07R60X204V23
	3 (72") tops, 4 (3 1/2") bases	60"	216"	29 1/4"	07R60X216V23
	3 (76") tops, 4 (3 1/2") bases	60"	228"	29 1/4"	07R60X228V23
	3 (80") tops, 4 (3 1/2") bases	60"	240"	29 1/4"	07R60X240V23

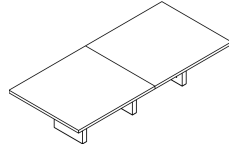

T1P	T2P	T1 upcharge	T2 upcharge	UMHW upcharge	UMPI upcharge	UMLK upcharge	SOHW upcharge	SOPI upcharge	SOLK upcharge
\$9,095.	\$9,527.	\$911.	\$1,267.	\$4,788.	\$3,480.	\$3,480.	\$8,341.	\$7,076.	\$7,076.
9,765.	10,266.	911.	1,267.	4,788.	3,480.	3,480.	8,341.	7,076.	7,076.
10,444.	11,036.	911.	1,267.	4,788.	3,480.	3,480.	8,341.	7,076.	7,076.
11,136.	11,776.	911.	1,267.	4,788.	3,480.	3,480.	8,341.	7,076.	7,076.
11,816.	12,524.	911.	1,267.	7,182.	5,221.	5,221.	12,512.	10,614.	10,614.
14,340.	15,123.	1,380.	1,913.	7,182.	5,221.	5,221.	12,512.	10,614.	10,614.
15,017.	15,888.	1,380.	1,913.	7,182.	5,221.	5,221.	12,512.	10,614.	10,614.
15,682.	16,640.	1,380.	1,913.	7,182.	5,221.	5,221.	12,512.	10,614.	10,614.
16,362.	17,371.	1,380.	1,913.	7,182.	5,221.	5,221.	12,512.	10,614.	10,614.
17,050.	18,151.	1,380.	1,913.	9,576.	6,961.	6,961.	16,682.	14,152.	14,152.
18,132.	19,308.	1,380.	1,913.	9,576.	6,961.	6,961.	16,682.	14,152.	14,152.
20,248.	21,483.	1,820.	2,534.	9,576.	6,961.	6,961.	16,682.	14,152.	14,152.
20,921.	22,220.	1,820.	2,534.	9,576.	6,961.	6,961.	16,682.	14,152.	14,152.
21,388.	22,741.	1,820.	2,534.	9,576.	6,961.	6,961.	16,682.	14,152.	14,152.
22,300.	23,734.	1,820.	2,534.	11,971.	8,701.	8,701.	20,853.	17,690.	17,690.

Order Code	Specification Information	Pricing Tiers
Example: 07R60X72V23	<i>To order please specify pattern number including:</i>	T1P = Tier 1 veneer top with painted base
07 JD Collection	1. Top finish: ()	T2P = Tier 2 veneer top with painted bases
R Rectangular Conference Table	2. Base finish: ()	T1 = Upcharge from T1P for Tier 1 veneer bases
60X Depth	3. Power and connectivity (Optional, blank for none):	T2 = Upcharge from T2P for Tier 2 veneer bases
72 Width	UMHW Under-mount, Hardwire	
V Veneer	UMPI Under-mount, Plug in	
2 2" thick top	UMLK Under-mount, Linkable	
3 3 1/2" wide Base	SOHW Slide out, Hardwired	
	SOPI Slide out, Plug in	
	SOLK Slide-out, Linkable	

Please refer to Materials and Finishes page 7 for specification details.

Application Notes
Tables ship knocked-down, assembly required.
Tables come with structural metal aprons, finished in metallic black powder (MC12).
Wire management handled vertically through bases and horizontally through aprons.
Bases can fully or partially conceal a floor core, pending the application. This ability will vary based on type, size, location of the floor core.
Finish and grain matched on tables with multi-piece tops
Undermount power units finished in metallic black powder (MC12).
Tops pre-drilled for installation of undermount power.
Undermount power unit comes with (x1) dual AC hardwire (HW) or plug in(PI) power module and (x2) single space blank plates. For additional connectivity, replace blank plates with Extron single or double space AAP modules as desired. For more information see extron.com .

Rectangular Conference Tables

60" Deep Tops, 29 1/4" High

2" Thick Tops, 6" wide Bases

description	t	d	w	h	pattern no.
Tables with 6" wide Bases	1 (72") tops, 2 (6") bases	60"	72"	29 1/4"	07R60X72V26
	1 (84") tops, 2 (6") bases	60"	84"	29 1/4"	07R60X84V26
	2 (48") tops, 2 (6") bases	60"	96"	29 1/4"	07R60X96V26
	2 (54") tops, 2 (6") bases	60"	108"	29 1/4"	07R60X108V26
	2 (60") tops, 2 (6") bases	60"	120"	29 1/4"	07R60X120V26
	2 (66") tops, 3 (6") bases	60"	132"	29 1/4"	07R60X132V26
	2 (72") tops, 3 (6") bases	60"	144"	29 1/4"	07R60X144V26
	3 (52") tops, 3 (6") bases	60"	156"	29 1/4"	07R60X156V26
	3 (56") tops, 3 (6") bases	60"	168"	29 1/4"	07R60X168V26
	3 (60") tops, 3 (6") bases	60"	180"	29 1/4"	07R60X180V26
	3 (64") tops, 3 (6") bases	60"	192"	29 1/4"	07R60X192V26
	3 (68") tops, 4 (6") bases	60"	204"	29 1/4"	07R60X204V26
	3 (72") tops, 4 (6") bases	60"	216"	29 1/4"	07R60X216V26
	3 (76") tops, 4 (6") bases	60"	228"	29 1/4"	07R60X228V26
	3 (80") tops, 4 (6") bases	60"	240"	29 1/4"	07R60X240V26

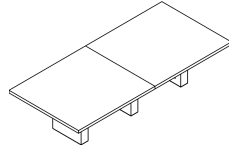

T1P	T2P	T1 upcharge	T2 upcharge	UMHW upcharge	UMPI upcharge	UMLK upcharge	SOHW upcharge	SOPI upcharge	SOLK upcharge
\$9,227.	\$9,648.	\$911.	\$1,267.	\$4,788.	\$3,480.	\$3,480.	\$8,341.	\$7,076.	\$7,076.
9,908.	10,404.	911.	1,267.	4,788.	3,480.	3,480.	8,341.	7,076.	7,076.
10,587.	11,159.	911.	1,267.	4,788.	3,480.	3,480.	8,341.	7,076.	7,076.
11,272.	11,907.	911.	1,267.	4,788.	3,480.	3,480.	8,341.	7,076.	7,076.
11,952.	12,665.	911.	1,267.	7,182.	5,221.	5,221.	12,512.	10,614.	10,614.
14,524.	15,331.	1,380.	1,913.	7,182.	5,221.	5,221.	12,512.	10,614.	10,614.
15,210.	16,072.	1,380.	1,913.	7,182.	5,221.	5,221.	12,512.	10,614.	10,614.
15,897.	16,836.	1,380.	1,913.	7,182.	5,221.	5,220.	12,512.	10,614.	10,614.
16,577.	17,564.	1,380.	1,913.	7,182.	5,221.	5,221.	12,512.	10,614.	10,614.
17,266.	18,341.	1,380.	1,913.	9,576.	6,961.	6,961.	16,682.	14,152.	14,152.
18,337.	19,480.	1,380.	1,913.	9,576.	6,961.	6,961.	16,682.	14,152.	14,152.
20,520.	21,761.	1,820.	2,534.	9,576.	6,961.	6,961.	16,682.	14,152.	14,152.
21,192.	22,490.	1,820.	2,534.	9,576.	6,961.	6,961.	16,682.	14,152.	14,152.
21,890.	23,257.	1,820.	2,534.	9,576.	6,961.	6,961.	16,682.	14,152.	14,152.
22,571.	23,991.	1,820.	2,534.	11,971.	8,701.	8,701.	20,853.	17,690.	17,690.

Order Code	Specification Information	Pricing Tiers
Example: 07R60X72V26	<i>To order please specify pattern number including:</i>	T1P = Tier 1 veneer top with painted base
07 JD Collection	1. Top finish: ()	T2P = Tier 2 veneer top with painted bases
R Rectangular Conference Table	2. Base finish: ()	T1 = Upcharge from T1P for Tier 1 veneer bases
60X Depth	3. Power and connectivity (Optional, blank for none):	T2 = Upcharge from T2P for Tier 2 veneer bases
72 Width	UMHW Under-mount, Hardwire	
V Veneer	UMPI Under-mount, Plug in	
2 2" thick top	UMLK Under-mount, Linkable	
6 6" wide Base	SOHW Slide out, Hardwired	
	SOPI Slide out, Plug in	
	SOLK Slide-out, Linkable	

Please refer to Materials and Finishes page 7 for specification details.

Application Notes
Tables ship knocked-down, assembly required.
Tables come with structural metal aprons, finished in metallic black powder (MC12).
Wire management handled vertically through bases and horizontally through aprons.
Bases can fully or partially conceal a floor core, pending the application. This ability will vary based on type, size, location of the floor core.
Finish and grain matched on tables with multi-piece tops
Undermount power units finished in metallic black powder (MC12).
Tops pre-drilled for installation of undermount power.
Undermount power unit comes with (x1) dual AC hardwire (HW) or plug in(PI) power module and (x2) single space blank plates. For additional connectivity, replace blank plates with Extron single or double space AAP modules as desired. For more information see extron.com .

Media Tables

Rectangular Media Tables

42" Deep Tops with 3 1/2" Wide Base

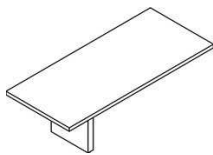
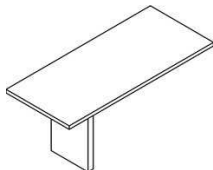
description	type	d	w	h	top thickness	pattern no.
	1 (60") top, 1 (3 1/2") base	42"	60"	29 1/4"	1 1/4"	07MR42X60V1330
	1 (72") top, 1 (3 1/2") base	42"	72"	29 1/4"	1 1/4"	07MR42X72V1330
	1 (84") top, 1 (3 1/2") base	42"	84"	29 1/4"	1 1/4"	07MR42X84V1330
	2 (48") top, 1 (3 1/2") base	42"	96"	29 1/4"	1 1/4"	07MR42X96V1330
	1 (60") top, 1 (3 1/2") base	42"	60"	29 1/4"	2"	07MR42X60V2330
	1 (72") top, 1 (3 1/2") base	42"	72"	29 1/4"	2"	07MR42X72V2330
	1 (84") top, 1 (3 1/2") base	42"	84"	29 1/4"	2"	07MR42X84V2330
	2 (48") top, 1 (3 1/2") base	42"	96"	29 1/4"	2"	07MR42X96V2330
	1 (60") top, 1 (3 1/2") base	42"	60"	41 1/2"	1 1/4"	07MR42X60V1342
	1 (72") top, 1 (3 1/2") base	42"	72"	41 1/2"	1 1/4"	07MR42X72V1342
	1 (84") top, 1 (3 1/2") base	42"	84"	41 1/2"	1 1/4"	07MR42X84V1342
	2 (48") top, 1 (3 1/2") base	42"	96"	41 1/2"	1 1/4"	07MR42X96V1342
	1 (60") top, 1 (3 1/2") base	42"	60"	41 1/2"	2"	07MR42X60V2342
	1 (72") top, 1 (3 1/2") base	42"	72"	41 1/2"	2"	07MR42X72V2342
	1 (84") top, 1 (3 1/2") base	42"	84"	41 1/2"	2"	07MR42X84V2342
	2 (48") top, 1 (3 1/2") base	42"	96"	41 1/2"	2"	07MR42X96V2342

	TP1	TP2	T1 upcharge	T2 upcharge
	\$5,931.	\$6,215.	\$448.	\$628.
	6,026.	6,317.	448.	628.
	6,047.	6,339.	448.	628.
	6,143.	6,443.	448.	628.
	6,080.	6,375.	448.	628.
	6,491.	6,818.	448.	628.
	6,198.	6,502.	448.	628.
	6,618.	6,956.	448.	628.
	6,386.	6,704.	448.	628.
	6,479.	6,807.	448.	628.
	6,510.	6,839.	448.	628.
	6,607.	6,944.	448.	628.
	6,804.	7,157.	448.	628.
	6,946.	7,310.	448.	628.
	6,936.	7,300.	448.	628.
	7,082.	7,457.	448.	628.

Order Code	Specification Information	Upcharges	Pricing Tiers
Example: 07MR42X60V1330	<i>To order please specify pattern number including:</i> 1. Top finish: () 2. Base finish: () 3. Power and connectivity (Optional, blank for none) Please refer to Materials and Finishes page 7 for specification details.	<i>Power and connectivity upcharges:</i>	
07 JD Collection		Code	Undermount Upchg
MR Media Table Rectangular		UMHW	Hardwire \$1197
42X Depth		UMPI	Plug in \$870
60 Width		UMLK	Undermount, Linkable \$870
V Veneer		SOHW	Slide out, Hardwired \$2085
1 1 1/4" thick top		SOPI	Slide out \$1769
3 3/2" wide Base		SOLK	Slide-out, Linkable \$1769
30 Height		Code	Topmount Upchg
		TSHW	Small \$1248
	TSPI	Small, Hardwired \$1213	
	TLHW	Large, Plug In \$1746	
	TLPI	Large, Plug In \$1711	

Application Notes
Tables comes with only one base.
Under-mount and slide-out power is always Black.
Tables ship knocked-down, assembly required.
Tables come with structural metal aprons, finished in metallic black powder (MC12).
Wire management handled vertically through bases and horizontally through aprons.
Bases can fully or partially conceal a floor core, pending the application. This ability will vary based on type, size, location of the floor core.
Finish and grain matched on tables with multi-piece tops
Undermount power units finished in metallic black powder (MC12).
Tops pre-drilled for installation of undermount power.
Undermount power unit comes with (x1) dual AC hardwire (HW) or plug in(PI) power module and (x2) single space blank plates. For additional connectivity, replace blank plates with Extron single or double space AAP modules as desired. For more information see extron.com .
Top-mount power is available in 5 finishes: Black = ECB White = ECGW Silver = ECS Brushed Aluminum = ECAL Stainless steel = ECSS.

Media Tables

Rectangular Media Tables

42" Deep Tops with 6" Wide Base

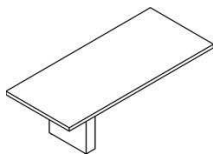
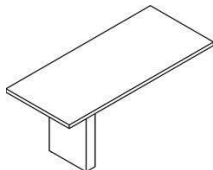
description	type	d	w	h	top thickness	pattern no.
	1 (60") top, 1 (6") base	42"	60"	29 1/4"	1 1/4"	07MR42X60V1630
	1 (72") top, 1 (6") base	42"	72"	29 1/4"	1 1/4"	07MR42X72V1630
	1 (84") top, 1 (6") base	42"	84"	29 1/4"	1 1/4"	07MR42X84V1630
	2 (48") top, 1 (6") base	42"	96"	29 1/4"	1 1/4"	07MR42X96V1630
	1 (60") top, 1 (6") base	42"	60"	29 1/4"	2"	07MR42X60V2630
	1 (72") top, 1 (6") base	42"	72"	29 1/4"	2"	07MR42X72V2630
	1 (84") top, 1 (6") base	42"	84"	29 1/4"	2"	07MR42X84V2630
	2 (48") top, 1 (6") base	42"	96"	29 1/4"	2"	07MR42X96V2630
	1 (60") top, 1 (6") base	42"	60"	41 1/2"	1 1/4"	07MR42X60V1642
	1 (72") top, 1 (6") base	42"	72"	41 1/2"	1 1/4"	07MR42X72V1642
	1 (84") top, 1 (6") base	42"	84"	41 1/2"	1 1/4"	07MR42X84V1642
	2 (48") top, 1 (6") base	42"	96"	41 1/2"	1 1/4"	07MR42X96V1642
	1 (60") top, 1 (6") base	42"	60"	41 1/2"	2"	07MR42X60V2642
	1 (72") top, 1 (6") base	42"	72"	41 1/2"	2"	07MR42X72V2642
	1 (84") top, 1 (6") base	42"	84"	41 1/2"	2"	07MR42X84V2642
	2 (48") top, 1 (6") base	42"	96"	41 1/2"	2"	07MR42X96V2642

	TP1	TP2	T1 upcharge	T2 upcharge
	\$6,840.	\$7,196.	\$448.	\$628.
	6,943.	7,307.	448.	628.
	6,975.	7,340.	448.	628.
	7,078.	7,453.	448.	628.
	7,265.	7,656.	448.	628.
	7,401.	7,800.	448.	628.
	7,407.	7,809.	448.	628.
	7,546.	7,957.	448.	628.
	7,295.	7,686.	448.	628.
	7,394.	7,794.	448.	628.
	7,437.	7,841.	448.	628.
	7,539.	7,950.	448.	628.
	7,721.	8,146.	448.	628.
	7,853.	8,291.	448.	628.
	7,872.	8,310.	448.	628.
	8,009.	8,457.	448.	628.

Order Code	Specification Information	Upcharges	Pricing Tiers	
Example: 07MR42X60V1630	<i>To order please specify pattern number including:</i> 1. Top finish: () 2. Base finish: () 3. Power and connectivity (Optional, blank for none) Please refer to Materials and Finishes page 7 for specification details.	<i>Power and connectivity upcharges:</i>		
07 JD Conference Tables		Code	Undermount	Upchg
MR Media Table Rectangular		UMHW	Hardwire	\$1197
42X Depth		UMPI	Plug in	\$870
60 Width		UMLK	Undermount, Linkable	\$870
V Veneer		SOHW	Slide out, Hardwired	\$2085
1 1 1/4" thick top		SOPI	Slide out Plug in	\$1769
6 6" wide Base		SOLK	Slide-out, Linkable	\$1769
30 Height		Code	Topmount	Upchg
		TSHW	Small Hardwired	\$1248
	TSPI	Small Plug In	\$1213	
	TLHW	Large Hardwired	\$1746	
	TLPI	Large, Plug In	\$1711	

Application Notes		
Tables comes with only one base.	Finish and grain matched on tables with multi-piece tops	Top-mount power is available in 5 finishes: Black = ECB White = ECGW Silver = ECS Brushed Aluminum = ECAL Stainless steel = ECSS.
Under-mount and slide-out power is always Black.	Undermount power units finished in metallic black powder (MC12).	
Tables ship knocked-down, assembly required.	Tops pre-drilled for installation of undermount power.	
Tables come with structural metal aprons, finished in metallic black powder (MC12).	Undermount power unit comes with (x1) dual AC hardwire (HW) or plug in(PI) power module and (x2) single space blank plates. For additional connectivity, replace blank plates with Extron single or double space AAP modules as desired. For more information see extron.com .	
Wire management handled vertically through bases and horizontally through aprons.		
Bases can fully or partially conceal a floor core, pending the application. This ability will vary based on type, size, location of the floor core.		

Media Tables

Rectangular Media Tables

48" Deep Tops with 3 1/2" wide Base

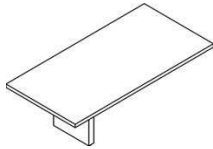
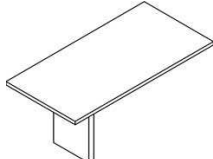
description	type	d	w	h	top thickness	pattern no.	
	Tables, 29 1/4" high	1 (60") top, 1 (3 1/2") base	48"	60"	29 1/4"	1 1/4"	07MR48X60V1330
	1 (72") top, 1 (3 1/2") base	48"	72"	29 1/4"	1 1/4"	07MR48X72V1330	
	1 (84") top, 1 (3 1/2") base	48"	84"	29 1/4"	1 1/4"	07MR48X84V1330	
	2 (48") top, 1 (3 1/2") base	48"	96"	29 1/4"	1 1/4"	07MR48X96V1330	
	1 (60") top, 1 (3 1/2") base	48"	60"	29 1/4"	2"	07MR48X60V2330	
	1 (72") top, 1 (3 1/2") base	48"	72"	29 1/4"	2"	07MR48X72V2330	
	1 (84") top, 1 (3 1/2") base	48"	84"	29 1/4"	2"	07MR48X84V2330	
	2 (48") top, 1 (3 1/2") base	48"	96"	29 1/4"	2"	07MR48X96V2330	
	Tables, 41 1/2" high	1 (60") top, 1 (3 1/2") base	48"	60"	41 1/2"	1 1/4"	07MR48X60V1342
	1 (72") top, 1 (3 1/2") base	48"	72"	41 1/2"	1 1/4"	07MR48X72V1342	
	1 (84") top, 1 (3 1/2") base	48"	84"	41 1/2"	1 1/4"	07MR48X84V1342	
	2 (48") top, 1 (3 1/2") base	48"	96"	41 1/2"	1 1/4"	07MR48X96V1342	
	1 (60") top, 1 (3 1/2") base	48"	60"	41 1/2"	2"	07MR48X60V2342	
	1 (72") top, 1 (3 1/2") base	48"	72"	41 1/2"	2"	07MR48X72V2342	
	1 (84") top, 1 (3 1/2") base	48"	84"	41 1/2"	2"	07MR48X84V2342	
	2 (48") top, 1 (3 1/2") base	48"	96"	41 1/2"	2"	07MR48X96V2342	

	TP1	TP2	T1 upcharge	T2 upcharge
	\$6,244.	\$6,551.	\$448.	\$628.
	6,347.	6,664.	448.	628.
	6,366.	6,684.	448.	628.
	6,471.	6,797.	448.	628.
	6,674.	7,016.	448.	628.
	6,813.	7,165.	448.	628.
	6,805.	7,158.	448.	628.
	6,945.	7,309.	448.	628.
	6,768.	7,117.	448.	628.
	6,862.	7,218.	448.	628.
	6,899.	7,260.	448.	628.
	6,995.	7,363.	448.	628.
	7,190.	7,574.	448.	628.
	7,331.	7,727.	448.	628.
	7,330.	7,724.	448.	628.
	7,475.	7,881.	448.	628.

Order Code	Specification Information	Upcharges	Pricing Tiers
Example: 07MR48X60V1330	<i>To order please specify pattern number including:</i>	<i>Power and connectivity upcharges:</i>	
07 JD Collection		Code	Undermount Upchg
MR Media Table Rectangular	1. Top finish: ()	UMHW	Hardwire \$1197
48X Depth	2. Base finish: ()	UMPI	Plug in \$870
60 Width	3. Power and connectivity (Optional, blank for none)	UMLK	Undermount, \$870
V Veneer	Please refer to Materials and Finishes page 7 for specification details.	SOHW	Slide out, \$2085
1 1 1/4" thick top			Hardwired
3 3/2" wide Base		SOPI	Slide out \$1769
30 Height		SOLK	Slide-out, \$1769
			Linkable
		Code	Topmount Upchg
		TSHW	Small \$1248
			Hardwired
		TSPI	Small \$1213
			Plug In
		TLHW	Large \$1746
			Hardwired
		TLPI	Large, Plug In \$1711

Application Notes		
Tables comes with only one base.	Finish and grain matched on tables with multi-piece tops	Top-mount power is available in 5 finishes:
Under-mount and slide-out power is always Black.	Undermount power units finished in metallic black powder (MC12).	Black = ECB
Tables ship knocked-down, assembly required.	Tops pre-drilled for installation of undermount power.	White = ECGW
Tables come with structural metal aprons, finished in metallic black powder (MC12).	Undermount power unit comes with (x1) dual AC hardwire (HW) or plug in(PI) power module and (x2) single space blank plates. For additional connectivity, replace blank plates with Extron single or double space AAP modules as desired. For more information see extron.com .	Silver = ECS
Wire management handled vertically through bases and horizontally through aprons.		Brushed Aluminum = ECAL
Bases can fully or partially conceal a floor core, pending the application. This ability will vary based on type, size, location of the floor core.		Stainless steel = ECSS.

Media Tables

Rectangular Media Tables

48" Deep Tops with 6" wide Base

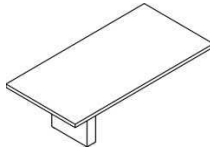
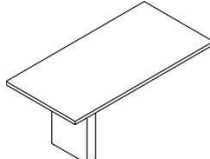
description	type	d	w	h	top thickness	pattern no.
	1 (60") top, 1 (6") base	48"	60"	29 1/4"	1 1/4"	07MR48X60V1630
	1 (72") top, 1 (6") base	48"	72"	29 1/4"	1 1/4"	07MR48X72V1630
	1 (84") top, 1 (6") base	48"	84"	29 1/4"	1 1/4"	07MR48X84V1630
	2 (48") top, 1 (6") base	48"	96"	29 1/4"	1 1/4"	07MR48X96V1630
	1 (60") top, 1 (6") base	48"	60"	29 1/4"	2"	07MR48X60V2630
	1 (72") top, 1 (6") base	48"	72"	29 1/4"	2"	07MR48X72V2630
	1 (84") top, 1 (6") base	48"	84"	29 1/4"	2"	07MR48X84V2630
	2 (48") top, 1 (6") base	48"	96"	29 1/4"	2"	07MR48X96V2630
	1 (60") top, 1 (6") base	48"	60"	41 1/2"	1 1/4"	07MR48X60V1642
	1 (72") top, 1 (6") base	48"	72"	41 1/2"	1 1/4"	07MR48X72V1642
	1 (84") top, 1 (6") base	48"	84"	41 1/2"	1 1/4"	07MR48X84V1642
	2 (48") top, 1 (6") base	48"	96"	41 1/2"	1 1/4"	07MR48X96V1642
	1 (60") top, 1 (6") base	48"	60"	41 1/2"	2"	07MR48X60V2642
	1 (72") top, 1 (6") base	48"	72"	41 1/2"	2"	07MR48X72V2642
	1 (84") top, 1 (6") base	48"	84"	41 1/2"	2"	07MR48X84V2642
	2 (48") top, 1 (6") base	48"	96"	41 1/2"	2"	07MR48X96V2642

	TP1	TP2	T1 upcharge	T2 upcharge
	\$7,284.	\$7,674.	\$448.	\$628.
	7,383.	7,781.	448.	628.
	7,426.	7,828.	448.	628.
	7,527.	7,939.	448.	628.
	7,706.	8,131.	448.	628.
	7,844.	8,279.	448.	628.
	7,858.	8,294.	448.	628.
	7,997.	8,444.	448.	628.
	7,797.	8,227.	448.	628.
	7,898.	8,339.	448.	628.
	7,949.	8,392.	448.	628.
	8,052.	8,506.	448.	628.
	8,221.	8,687.	448.	628.
	8,356.	8,833.	448.	628.
	8,383.	8,860.	448.	628.
	8,519.	9,009.	448.	628.

Order Code	Specification Information	Upcharges	Pricing Tiers
Example: 07MR48X60V1330	<i>To order please specify pattern number including:</i>	<i>Power and connectivity upcharges:</i>	
07 JD Collection		Code	Undermount Upchg
MR Media Table Rectangular	1. Top finish: ()	UMHW Hardwire \$1197	T1P = Tier 1 veneer top with painted base
48X Depth	2. Base finish: ()	UMPI Plug in \$870	T2P = Tier 2 veneer top with painted bases
60 Width	3. Power and connectivity (Optional, blank for none)	UMLK Undermount, Linkable \$870	T1 = Upcharge from T1P for Tier 1 veneer bases
V Veneer	Please refer to Materials and Finishes page 7 for specification details.	SOHW Slide out, Hardwired \$2085	T2 = Upcharge from T2P for Tier 2 veneer bases
1 1 1/4" thick top		SOPI Slide out Plug in \$1769	
6 6" wide Base		SOLK Slide-out, Linkable \$1769	
30 Height		Code Topmount Upchg	
		TSHW Small Hardwired \$1248	
		TSPI Small Plug In \$1213	
	TLHW Large Hardwired \$1746		
	TLPI Large, Plug In \$1711		

Application Notes		
Tables comes with only one base.	Finish and grain matched on tables with multi-piece tops	Top-mount power is available in 5 finishes: Black = ECB White = ECGW Silver = ECS Brushed Aluminum = ECAL Stainless steel = ECSS.
Under-mount and slide-out power is always Black.	Undermount power units finished in metallic black powder (MC12).	
Tables ship knocked-down, assembly required.	Tops pre-drilled for installation of undermount power.	
Tables come with structural metal aprons, finished in metallic black powder (MC12).	Undermount power unit comes with (x1) dual AC hardwire (HW) or plug in(PI) power module and (x2) single space blank plates. For additional connectivity, replace blank plates with Extron single or double space AAP modules as desired. For more information see extron.com .	
Wire management handled vertically through bases and horizontally through aprons.		
Bases can fully or partially conceal a floor core, pending the application. This ability will vary based on type, size, location of the floor core.		

Media Tables

Rectangular Media Tables

54" Deep Tops with 3 1/2" wide Base

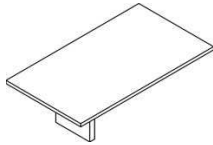
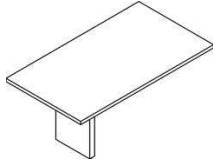
description	type	d	w	h	top thickness	pattern no.
 <p>Tables, 29 1/4" high</p>	1 (60") top, 1 (3 1/2") base	54"	60"	29 1/4"	1 1/4"	07MR54X60V1330
	1 (72") top, 1 (3 1/2") base	54"	72"	29 1/4"	1 1/4"	07MR54X72V1330
	1 (84") top, 1 (3 1/2") base	54"	84"	29 1/4"	1 1/4"	07MR54X84V1330
	2 (48") top, 1 (3 1/2") base	54"	96"	29 1/4"	1 1/4"	07MR54X96V1330
	1 (60") top, 1 (3 1/2") base	54"	60"	29 1/4"	2"	07MR54X60V2330
	1 (72") top, 1 (3 1/2") base	54"	72"	29 1/4"	2"	07MR54X72V2330
	1 (84") top, 1 (3 1/2") base	54"	84"	29 1/4"	2"	07MR54X84V2330
	2 (48") top, 1 (3 1/2") base	54"	96"	29 1/4"	2"	07MR54X96V2330
 <p>Tables, 41 1/2" high</p>	1 (60") top, 1 (3 1/2") base	54"	60"	41 1/2"	1	07MR54X60V1342
	1 (72") top, 1 (3 1/2") base	54"	72"	41 1/2"	1 1/4"	07MR54X72V1342
	1 (84") top, 1 (3 1/2") base	54"	84"	41 1/2"	1 1/4"	07MR54X84V1342
	2 (48") top, 1 (3 1/2") base	54"	96"	41 1/2"	1 1/4"	07MR54X96V1342
	1 (60") top, 1 (3 1/2") base	54"	60"	41 1/2"	2"	07MR54X60V2342
	1 (72") top, 1 (3 1/2") base	54"	72"	41 1/2"	2"	07MR54X72V2342
	1 (84") top, 1 (3 1/2") base	54"	84"	41 1/2"	2"	07MR54X84V2342
	2 (48") top, 1 (3 1/2") base	54"	96"	41 1/2"	2"	07MR54X96V2342

	TP1	TP2	T1 upcharge	T2 upcharge
	\$5,927.	\$6,209.	\$448.	\$628.
	6,670.	7,013.	448.	628.
	6,043.	6,334.	448.	628.
	6,801.	7,154.	448.	628.
	6,986.	7,355.	448.	628.
	7,126.	7,505.	448.	628.
	7,124.	7,501.	448.	628.
	7,264.	7,654.	448.	628.
	7,145.	7,525.	448.	628.
	7,242.	7,630.	448.	628.
	7,285.	7,675.	448.	628.
	7,384.	7,783.	448.	628.
	7,574.	7,989.	448.	628.
	7,703.	8,127.	448.	628.
	7,721.	8,148.	448.	628.
	7,853.	8,291.	448.	628.

Order Code	Specification Information	Upcharges	Pricing Tiers
Example: 07MR54X60V1330	<i>To order please specify pattern number including:</i>	<i>Power and connectivity upcharges:</i>	
07 JD Collection		Code	Undermount Upchg
MR Media Table Rectangular	1. Top finish: ()	UMHW Hardwire \$1197	T1P = Tier 1 veneer top with painted base
54X Depth	2. Base finish: ()	UMPI Plug in \$870	T2P = Tier 2 veneer top with painted bases
60 Width	3. Power and connectivity (Optional, blank for none)	UMLK Undermount, \$870	T1 = Upcharge from T1P for Tier 1 veneer bases
V Veneer	Please refer to Materials and Finishes page 7 for specification details.	SOHW Slide out, \$2085	T2 = Upcharge from T2P for Tier 2 veneer bases
1 1 1/4" thick top		Slide out Hardwired	
3 3/2" wide Base		SOPI Slide out \$1769	
30 Height		SOLK Slide-out, \$1769	
		Linkable	
		Code Topmount Upchg	
	TSHW Small \$1248		
	Hardwired		
	TSPI Small \$1213		
	Plug In		
	TLHW Large \$1746		
	Hardwired		
	TLPI Large, Plug In \$1711		

Application Notes
Tables comes with only one base.
Under-mount and slide-out power is always Black.
Tables ship knocked-down, assembly required.
Tables come with structural metal aprons, finished in metallic black powder (MC12).
Wire management handled vertically through bases and horizontally through aprons.
Bases can fully or partially conceal a floor core, pending the application. This ability will vary based on type, size, location of the floor core.
Finish and grain matched on tables with multi-piece tops
Undermount power units finished in metallic black powder (MC12).
Tops pre-drilled for installation of undermount power.
Undermount power unit comes with (x1) dual AC hardwire (HW) or plug in(PI) power module and (x2) single space blank plates. For additional connectivity, replace blank plates with Extron single or double space AAP modules as desired. For more information see extron.com .
Top-mount power is available in 5 finishes: Black = ECB White = ECGW Silver = ECS Brushed Aluminum = ECAL Stainless steel = ECSS.

Media Tables

Rectangular Media Tables

54" Deep Tops with 6" wide Base

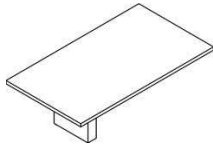
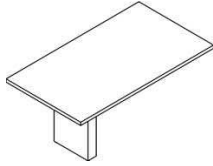
description	type	d	w	h	top thickness	pattern no.
	1 (60") top, 1 (6") base	54"	60"	29 1/4"	1 1/4"	07MR54X60V1630
	1 (72") top, 1 (6") base	54"	72"	29 1/4"	1 1/4"	07MR54X72V1630
	1 (84") top, 1 (6") base	54"	84"	29 1/4"	1 1/4"	07MR54X84V1630
	2 (48") top, 1 (6") base	54"	96"	29 1/4"	1 1/4"	07MR54X96V1630
	1 (60") top, 1 (6") base	54"	60"	29 1/4"	2"	07MR54X60V2630
	1 (72") top, 1 (6") base	54"	72"	29 1/4"	2"	07MR54X72V2630
	1 (84") top, 1 (6") base	54"	84"	29 1/4"	2"	07MR54X84V2630
	2 (48") top, 1 (6") base	54"	96"	29 1/4"	2"	07MR54X96V2630
	1 (60") top, 1 (6") base	54"	60"	41 1/2"	1 1/4"	07MR54X60V1642
	1 (72") top, 1 (6") base	54"	72"	41 1/2"	1 1/4"	07MR54X72V1642
	1 (84") top, 1 (6") base	54"	84"	41 1/2"	1 1/4"	07MR54X84V1642
	2 (48") top, 1 (6") base	54"	96"	41 1/2"	1 1/4"	07MR54X96V1642
	1 (60") top, 1 (6") base	54"	60"	41 1/2"	2"	07MR54X60V2642
	1 (72") top, 1 (6") base	54"	72"	41 1/2"	2"	07MR54X72V2642
	1 (84") top, 1 (6") base	54"	84"	41 1/2"	2"	07MR54X84V2642
	2 (48") top, 1 (6") base	54"	96"	41 1/2"	2"	07MR54X96V2642

	TP1	TP2	T1 upcharge	T2 upcharge
	\$7,727.	\$8,153.	\$448.	\$628.
	7,826.	8,260.	448.	628.
	7,877.	8,316.	448.	628.
	7,979.	8,426.	448.	628.
	8,150.	8,611.	448.	628.
	8,290.	8,761.	448.	628.
	8,310.	8,783.	448.	628.
	8,453.	8,936.	448.	628.
	8,301.	8,773.	448.	628.
	8,403.	8,883.	448.	628.
	8,462.	8,949.	448.	628.
	8,567.	9,060.	448.	628.
	8,727.	9,232.	448.	628.
	8,866.	9,384.	448.	628.
	8,898.	9,418.	448.	628.
	9,040.	9,572.	448.	628.

Order Code	Specification Information	Upcharges	Pricing Tiers
Example: 07MR54X60V1330	<i>To order please specify pattern number including:</i>	<i>Power and connectivity upcharges:</i>	
07 JD Collection		Code	Undermount Upchg
MR Media Table Rectangular	1. Top finish: ()	UMHW	Hardwire \$1197
54X Depth	2. Base finish: ()	UMPI	Plug in \$870
60 Width	3. Power and connectivity (Optional, blank for none)	UMLK	Undermount, \$870
V Veneer	Please refer to Materials and Finishes page 7 for specification details.	SOHW	Slide out, \$2085
1 1 1/4" thick top			Hardwired
6 6" wide Base		SOPI	Slide out \$1769
30 Height		SOLK	Slide-out, \$1769
			Linkable
		Code	Topmount Upchg
		TSHW	Small \$1248
			Hardwired
		TSPI	Small \$1213
			Plug In
	TLHW	Large \$1746	
		Hardwired	
	TLPI	Large, Plug In \$1711	

Application Notes		
Tables comes with only one base.	Finish and grain matched on tables with multi-piece tops	Top-mount power is available in 5 finishes: Black = ECB White = ECGW Silver = ECS Brushed Aluminum = ECAL Stainless steel = ECSS.
Under-mount and slide-out power is always Black.	Undermount power units finished in metallic black powder (MC12).	
Tables ship knocked-down, assembly required.	Tops pre-drilled for installation of undermount power.	
Tables come with structural metal aprons, finished in metallic black powder (MC12).	Undermount power unit comes with (x1) dual AC hardwire (HW) or plug in(PI) power module and (x2) single space blank plates. For additional connectivity, replace blank plates with Extron single or double space AAP modules as desired. For more information see extron.com .	
Wire management handled vertically through bases and horizontally through aprons.		
Bases can fully or partially conceal a floor core, pending the application. This ability will vary based on type, size, location of the floor core.		

Media Tables

Trapezoid Media Tables

Tables with 3 1/2" wide Base

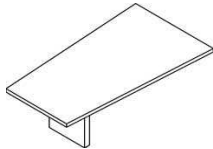
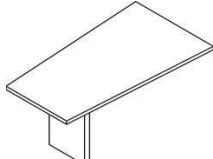
description	type	d	w	h	top thickness	pattern no.
 <p>Tables, 29 1/4" high</p>	1 (60") top, 1 (3 1/2") base	42"/54"	60"	29 1/4"	1 1/4"	07MT4254X60V1330
	1 (72") top, 1 (3 1/2") base	42"/54"	72"	29 1/4"	1 1/4"	07MT4254X72V1330
	1 (84") top, 1 (3 1/2") base	42"/54"	84"	29 1/4"	1 1/4"	07MT4254X84V1330
	2 (48") top, 1 (3 1/2") base	42"/54"	96"	29 1/4"	1 1/4"	07MT4254X96V1330
	1 (60") top, 1 (3 1/2") base	42"/54"	60"	29 1/4"	2"	07MT4254X60V2330
	1 (72") top, 1 (3 1/2") base	42"/54"	72"	29 1/4"	2"	07MT4254X72V2330
	1 (84") top, 1 (3 1/2") base	42"/54"	84"	29 1/4"	2"	07MT4254X84V2330
	2 (48") top, 1 (3 1/2") base	42"/54"	96"	29 1/4"	2"	07MT4254X96V2330
 <p>Tables, 41 1/2" high</p>	1 (60") top, 1 (3 1/2") base	42"/54"	60"	41 1/2"	1 1/4"	07MT4254X60V1342
	1 (72") top, 1 (3 1/2") base	42"/54"	72"	41 1/2"	1 1/4"	07MT4254X72V1342
	1 (84") top, 1 (3 1/2") base	42"/54"	84"	41 1/2"	1 1/4"	07MT4254X84V1342
	2 (48") top, 1 (3 1/2") base	42"/54"	96"	41 1/2"	1 1/4"	07MT4254X96V1342
	1 (60") top, 1 (3 1/2") base	42"/54"	60"	41 1/2"	2"	07MT4254X60V2342
	1 (72") top, 1 (3 1/2") base	42"/54"	72"	41 1/2"	2"	07MT4254X72V2342
	1 (84") top, 1 (3 1/2") base	42"/54"	84"	41 1/2"	2"	07MT4254X84V2342
	2 (48") top, 1 (3 1/2") base	42"/54"	96"	41 1/2"	2"	07MT4254X96V2342

	TP1	TP2	T1 upcharge	T2 upcharge
	\$5,927.	\$6,209.	\$448.	\$628.
	6,670.	7,013.	448.	628.
	6,043.	6,334.	448.	628.
	6,801.	7,154.	448.	628.
	6,986.	7,355.	448.	628.
	7,126.	7,505.	448.	628.
	7,124.	7,501.	448.	628.
	7,264.	7,654.	448.	628.
	7,145.	7,525.	448.	628.
	7,242.	7,630.	448.	628.
	7,285.	7,675.	448.	628.
	7,384.	7,783.	448.	628.
	7,574.	7,989.	448.	628.
	7,703.	8,127.	448.	628.
	7,721.	8,148.	448.	628.
	7,853.	8,291.	448.	628.

Order Code	Specification Information	Upcharges	Pricing Tiers
Example: 07MT4254X60V1330	<i>To order please specify pattern number including:</i>	<i>Power and connectivity upcharges:</i>	
07 JD Collection		Code	Undermount Upchg
MT Media Table Trapezoid	1. Top finish: ()	UMHW Hardwire \$1197	T1P = Tier 1 veneer top with painted base
4254X Depth	2. Base finish: ()	UMPI Plug in \$870	T2P = Tier 2 veneer top with painted bases
60 Width	3. Power and connectivity (Optional, blank for none)	UMLK Undermount, Linkable \$870	T1 = Upcharge from T1P for Tier 1 veneer bases
V Veneer	Please refer to Materials and Finishes page 7 for specification details.	SOHW Slide out, Hardwired \$2085	T2 = Upcharge from T2P for Tier 2 veneer bases
1 1 1/4" thick top		SOPI Slide out Plug in \$1769	These prices only include the table top. Go to page 42 for Media Wall options.
3 3 1/2" wide Base		SOLK Slide-out, Linkable \$1769	
30 Height		Code	Topmount Upchg
		TSHW Small Hardwired \$1248	
		TSPI Small Hardwired Plug In \$1213	
	TLHW Large Hardwired Plug In \$1746		
	TLPI Large, Plug In \$1711		

Application Notes
Tables comes with only one base.
Under-mount and slide-out power is always Black.
Tables ship knocked-down, assembly required.
Tables come with structural metal aprons, finished in metallic black powder (MC12).
Wire management handled vertically through bases and horizontally through aprons.
Bases can fully or partially conceal a floor core, pending the application. This ability will vary based on type, size, location of the floor core.
Finish and grain matched on tables with multi-piece tops
Undermount power units finished in metallic black powder (MC12).
Tops pre-drilled for installation of undermount power.
Undermount power unit comes with (x1) dual AC hardwire (HW) or plug in(PI) power module and (x2) single space blank plates. For additional connectivity, replace blank plates with Extron single or double space AAP modules as desired. For more information see extron.com .
Top-mount power is available in 5 finishes: Black = ECB White = ECGW Silver = ECS Brushed Aluminum = ECAL Stainless steel = ECSS.

Media Tables

Trapezoid Media Tables

Tables with 6" wide Base

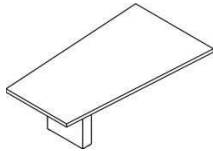
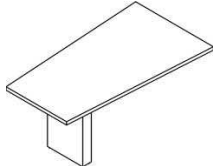
description	type	d	w	h	top thickness	pattern no.
 <p>Tables, 29 1/4" high</p>	1 (60") top, 1 (6") base	42"/54"	60"	29 1/4"	1 1/4"	07MT4254X60V1630
	1 (72") top, 1 (6") base	42"/54"	72"	29 1/4"	1 1/4"	07MT4254X72V1630
	1 (84") top, 1 (6") base	42"/54"	84"	29 1/4"	1 1/4"	07MT4254X84V1630
	2 (48") top, 1 (6") base	42"/54"	96"	29 1/4"	1 1/4"	07MT4254X96V1630
	1 (60") top, 1 (6") base	42"/54"	60"	29 1/4"	2"	07MT4254X60V2630
	1 (72") top, 1 (6") base	42"/54"	72"	29 1/4"	2"	07MT4254X72V2630
	1 (84") top, 1 (6") base	42"/54"	84"	29 1/4"	2"	07MT4254X84V2630
	2 (48") top, 1 (6") base	42"/54"	96"	29 1/4"	2"	07MT4254X96V2630
 <p>Tables, 41 1/2" high</p>	1 (60") top, 1 (6") base	42"/54"	60"	41 1/2"	1 1/4"	07MT4254X60V1642
	1 (72") top, 1 (6") base	42"/54"	72"	41 1/2"	1 1/4"	07MT4254X72V1642
	1 (84") top, 1 (6") base	42"/54"	84"	41 1/2"	1 1/4"	07MT4254X84V1642
	2 (48") top, 1 (6") base	42"/54"	96"	41 1/2"	1 1/4"	07MT4254X96V1642
	1 (60") top, 1 (6") base	42"/54"	60"	41 1/2"	2"	07MT4254X60V2642
	1 (72") top, 1 (6") base	42"/54"	72"	41 1/2"	2"	07MT4254X72V2642
	1 (84") top, 1 (6") base	42"/54"	84"	41 1/2"	2"	07MT4254X84V2642
	2 (48") top, 1 (6") base	42"/54"	96"	41 1/2"	2"	07MT4254X96V2642

	TP1	TP2	T1 upcharge	T2 upcharge
	\$7,727.	\$8,153.	\$448.	\$628.
	7,826.	8,260.	448.	628.
	7,877.	8,316.	448.	628.
	7,979.	8,426.	448.	628.
	8,150.	8,611.	448.	628.
	8,290.	8,761.	448.	628.
	8,310.	8,783.	448.	628.
	8,453.	8,936.	448.	628.
	8,301.	8,773.	448.	628.
	8,403.	8,883.	448.	628.
	8,462.	8,949.	448.	628.
	8,567.	9,060.	448.	628.
	8,727.	9,232.	448.	628.
	8,866.	9,384.	448.	628.
	8,898.	9,418.	448.	628.
	9,040.	9,572.	448.	628.

Order Code	Specification Information	Upcharges	Pricing Tiers	
Example: 07MT4254X60V1330	<p>To order please specify pattern number including:</p> <ol style="list-style-type: none"> Top finish: () Base finish: () Power and connectivity (Optional, blank for none) <p>Please refer to Materials and Finishes page 7 for specification details.</p>	Power and connectivity upcharges:		
07 JD Collection		Code	Undermount	Upchg
MT Media Table Trapezoid		UMHW	Hardwire	\$1124
4254X Depth		UMPI	Plug in	\$817
60 Width		UMLK	Undermount, Linkable	\$817
V Veneer		SOHW	Slide out, Hardwired	\$1958
1 1 1/4" thick top		SOPI	Slide out Plug in	\$1661
6 6" wide Base		SOLK	Slide-out, Linkable	\$1661
30 Height		Code	Topmount	Upchg
		TSHW	Small Hardwired	\$1172
	TSPI	Small Plug In	\$1139	
	TLHW	Large Hardwired	\$1639	
	TLPI	Large, Plug In	\$1607	

Application Notes		
Tables comes with only one base.	Finish and grain matched on tables with multi-piece tops	Top-mount power is available in 5 finishes: Black = ECB White = ECGW Silver = ECS Brushed Aluminum = ECAL Stainless steel = ECSS.
Under-mount and slide-out power is always Black.	Undermount power units finished in metallic black powder (MC12).	
Tables ship knocked-down, assembly required.	Tops pre-drilled for installation of undermount power.	
Tables come with structural metal aprons, finished in metallic black powder (MC12).	Undermount power unit comes with (x1) dual AC hardwire (HW) or plug in(PI) power module and (x2) single space blank plates. For additional connectivity, replace blank plates with Extron single or double space AAP modules as desired. For more information see extron.com .	
Wire management handled vertically through bases and horizontally through aprons.		
Bases can fully or partially conceal a floor core, pending the application. This ability will vary based on type, size, location of the floor core.		

Media Tables
Media Walls

description	type	w	h	wall thickness	pattern no.
Full Media Wall	30"H Table	56 1/2"	79 7/8"	6 1/2"	07MFSI57797
	42"H Table	56 1/2"	79 7/8"	6 1/2"	07MFST57797
Partial Media Wall	Partial	24 1/2"	36"	2"	07MPH24362
Media Wall Bracket					07MBR

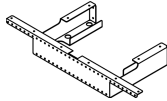
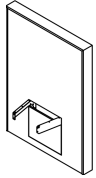

	Tier 1	Tier 2	list
	\$10,389.	\$10,586.	
	10,389.	10,586.	
	3,075.	3,257.	
	0.	0.	1,000.

Order Code	Specification Information	Pricing Tiers
Example: 07MPH24362	<i>To order please specify pattern number including:</i>	T1 = Upcharge from T1P for Tier 1 veneer bases
07 JD Collection	1. Trim Finish	T2 = Upcharge from T2P for Tier 2 veneer bases
MP Media Partial Height Wall	2. Table Side Finish	Media Wall bracket is only for the cantilever table mounted on an architectural wall. For the Full and Partial Media Wall, the bracket is included.
24 Width	3. Other Side Finish	
36 Height	Please refer to Materials and Finishes page 7 for specification details.	
2 Thickness		

Bookcase 29" and 35" High

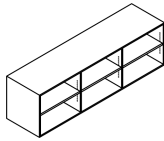
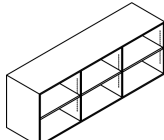
description	type	d	w	h	pattern no.
 Bookcase, 29" High	56" wide	24"	56"	29"	07CRB292456
	74" wide	24"	74"	29"	07CRB292474
	92" wide	24"	92"	29"	07CRB292492
 Bookcase, 35" High	56" wide	24"	56"	35"	07CRB352456
	74" wide	24"	74"	35"	07CRB352474
	92" wide	24"	92"	35"	07CRB352492

	Painted	T1	T2
	\$4,742.	\$6,323.	\$7,811.
	5,534.	7,386.	9,263.
	6,326.	8,442.	10,723.
	5,162.	6,853.	8,497.
	6,076.	8,054.	10,140.
	6,991.	9,265.	11,780.

Order Code	Specification Information	Pricing Tiers
Example: 07CRB292456	<i>To order please specify pattern number including:</i>	Painted Case
07 JD Collection	1. Case Finish	T1 = Tier 1 veneer case
CR Credenza	Please refer to Materials and Finishes page 7 for specification details.	T2 = Tier 2 veneer case
B Bookcase		
29 29" High		
24 24" Deep		
56 56" Wide		

Application Notes	
<p>Construction: Top and end panels are 3/4" thick wood panels with mitered corners.</p> <p>Bottom panel is a 3/4" thick wood panel that is butt-jointed to the end panels, but cleverly done to give the appearance of a mitered corner on the front.</p> <p>Back panel is a 3/4" thick inset wood panel.</p> <p>Back panel is picture-framed by the top and end panels exposing the mitered corners while the bottom panel set back and hidden from view behind the back panel.</p>	<p>Vertical divider panels are 3/4" thick wood panels.</p> <p>Shelves are 1" thick wood panels and adjustable in 32 mm (1 1/4") increments with a nominal minimum clearance of 6" on top or bottom.</p> <p>Bases are 2" high wood panels recessed 2" on all sides.</p> <p>All components finished to match in either a veneer or satin lacquer finish.</p>

3 Position Credenzas

29" High

description	type	d	w	h	pattern no.
3 Positions with File Drawer, Hinge Door, Pull Out-Trash & Box Drawers configuration options, 29" High	3 x 18" wide inserts	24"	55 3/4"	29"	07CRM292456
3 Positions with AV Hinge door, Cool Drawer, File Drawer, Hinge Door, Pull Out-Trash and Box Drawers configuration options, 29" High	1 x 18" w insert & 2 x 24" w insert on both ends	24"	67 3/4"	29"	07CRM292468
	2 x 18" w inserts & 1 x 24" w insert on the left	24"	61 3/4"	29"	07CRM292462L
	2 x 18" w inserts & 1 x 24" w insert on the right	24"	61 3/4"	29"	07CRM292462R

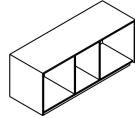
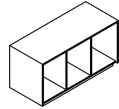

Painted	T1	T2
\$4,429.	\$5,686.	\$6,661.
4,887.	6,256.	7,385.
4,662.	5,968.	7,020.
4,662.	5,968.	7,020.

Order Code	Specification Information	Pricing Tiers
Example: 07CRM292456	<i>To order please specify pattern number including:</i>	Note that the credenzas are priced as modular components. The prices listed above are the case prices. The inserts are priced separately. Please refer to page 58 to 67 for insert pricing.
07 JD Collection	1. Case Finish	Painted Case
CR Credenza	2. Front Finish	T1 = Tier 1 veneer case
M Modular	3. Position 1 insert configuration	T2 = Tier 2 veneer case
29 29" High	4. Position 2 insert configuration	<i>Pull Finish Options:</i>
24 24" Deep	5. Position 3 insert configuration	HBN = Brushed Nickel
56 56" Wide	6. Pull Finish	HMB = Matt Black
	Positions are specified left to right. Please refer to page 58 to 67 for insert configuration codes.	
	Pull finish only applies to the following insert configuration types: file drawer, box drawer, pull out trash and cool drawer.	
	Please refer to Materials and Finishes page 7 for specification details.	

Application Notes
<p>Construction: Top and end panels are 3/4" thick wood panels with mitered corners.</p> <p>Bottom panel is a 3/4" thick wood panel that is butt-jointed to the end panels.</p> <p>Back panel is a 3/4" thick inset wood panel, picture-framed by the top and end panels exposing the mitered corners while the bottom panel is set back and hidden from view behind the back panel.</p> <p>Back panel is picture-framed by the top and end panels exposing the mitered corners while the bottom panel set back and hidden from view behind the back panel.</p>
<p>Bases are 2" high wood panels recessed 2" on all sides.</p> <p>A/V Rack and/or Cool Drawer 24" wide insert positions are equipped with an 18" wide x 19" high cutout in the back panel as well as two 6" wide x 1" deep grommets along the front edge of the bottom panel for ventilation.</p> <p>All components finished to match in either a veneer or satin lacquer finish.</p>

3 Position Credenzas

35" High

description	type	d	w	h	pattern no.
3 Positions with File Drawer, Hinge Door, Pull Out-Trash & Box Drawers configuration options, 35" High	3 x 18" wide inserts	24"	55 3/4"	35"	07CRM352456

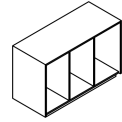

3 Positions with AV Hinge door, Cool Drawer, File Drawer, Hinge Door, Pull Out-Trash and Box Drawers configuration options, 35" High	1 x 18" w insert & 2 x 24" w insert on both ends	24"	67 1/4"	35"	07CRM352468
	2 x 18" w inserts & 1 x 24" insert on the left	24"	61 3/4"	35"	07CRM352462L
	2 x 18" w inserts & 1 x 24" insert on the right	24"	61 3/4"	35"	07CRM352462R

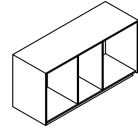

	Painted	T1	T2
	\$4,807.	\$6,144.	\$7,227.
	5,340.	6,794.	8,039.
	5,077.	6,472.	7,633.
	5,077.	6,472.	7,633.

Order Code	Specification Information	Pricing Tiers	
Example: 07CRM352456	<i>To order please specify pattern number including:</i>		Note that the credenzas are priced as modular components. The prices listed above are the case prices. The inserts are priced separately. Please refer to page 58 to 67 for insert pricing.
07 JD Collection			
CR Credenza	1. Case Finish	Painted Case	
M Modular	2. Front Finish	T1 = Tier 1 veneer case	
35 35" High	3. Position 1 insert configuration	T2 = Tier 2 veneer case	
24 24" Deep	4. Position 2 insert configuration	<i>Pull Finish Options:</i>	
56 56" Wide	5. Position 3 insert configuration	HBN = Brushed Nickel	
	6. Pull Finish	HMB = Matt Black	
	Positions are specified left to right. Please refer to page 58 to 67 for insert configuration codes.		
	Pull finish only applies to the following insert configuration types: file drawer, box drawer, pull out trash and cool drawer.		
	Please refer to Materials and Finishes page 7 for specification details.		

Application Notes	
Construction: Top and end panels are 3/4" thick wood panels with mitered corners.	Bases are 2" high wood panels recessed 2" on all sides.
Bottom panel is a 3/4" thick wood panel that is butt-jointed to the end panels.	A/V Rack and/or Cool Drawer 24" wide insert positions are equipped with an 18" wide x 19" high cutout in the back panel as well as two 6" wide x 1" deep grommets along the front edge of the bottom panel for ventilation.
Back panel is a 3/4" thick inset wood panel, picture-framed by the top and end panels exposing the mitered corners while the bottom panel is set back and hidden from view behind the back panel.	All components finished to match in either a veneer or satin lacquer finish.
Back panel is picture-framed by the top and end panels exposing the mitered corners while the bottom panel set back and hidden from view behind the back panel.	

4 Position Credenzas

29" High

description	type	d	w	h	pattern no.
4 Positions with File Drawer, Hinge Door, Pull Out-Trash & Box Drawers configuration options, 29" High	4 x 18" wide inserts	24"	73 3/4"	29"	07CRM292474

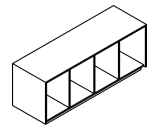

4 Positions with AV Hinge door, Cool Drawer, File Drawer, Hinge Door, Pull Out-Trash and Box Drawers configuration options, 29" High	2 x 18" w inserts & 2 x 24" w inserts on both ends	24"	85 3/4"	29"	07CRM292486
	3 x 18" w inserts & 1 x 24" w insert on the left	24"	79 3/4"	29"	07CRM292480L
	3 x 18" w inserts & 1 x 24" w insert on the right	24"	79 3/4"	29"	07CRM292480R

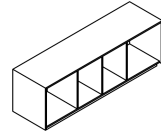

	Painted	T1	T2
	\$5,116.	\$6,538.	\$7,754.
	5,580.	7,106.	8,472.
	5,353.	6,397.	8,109.
	5,353.	6,397.	8,109.

Order Code

Example:	07CRM292474
07	JD Collection
CR	Credenza
M	Modular
29	29" High
24	24" Deep
74	74" Wide

Specification Information

To order please specify pattern number including:

1. Case Finish
2. Front Finish
3. Position 1 insert configuration
4. Position 2 insert configuration
5. Position 3 insert configuration
6. Position 4 insert configuration
7. Pull Finish

Positions are specified left to right. Please refer to page 58 to 67 for insert configuration codes.

Pull finish only applies to the following insert configuration types: file drawer, box drawer, pull out trash and cool drawer.

Please refer to Materials and Finishes page 7 for specification details.

Pricing Tiers

Painted Case
T1 = Tier 1 veneer case
T2 = Tier 2 veneer case

Pull Finish Options:
HBN = Brushed Nickel
HMB = Matt Black

Note that the credenzas are priced as modular components. The prices listed above are the case prices. The inserts are priced separately. Please refer to page 58 to 67 for insert pricing.

Application Notes

Construction:
 Top and end panels are 3/4" thick wood panels with mitered corners.

Bottom panel is a 3/4" thick wood panel that is butt-jointed to the end panels.

Back panel is a 3/4" thick inset wood panel, picture-framed by the top and end panels exposing the mitered corners while the bottom panel is set back and hidden from view behind the back panel.

Back panel is picture-framed by the top and end panels exposing the mitered corners while the bottom panel set back and hidden from view behind the back panel.

Bases are 2" high wood panels recessed 2" on all sides.

A/V Rack and/or Cool Drawer 24" wide insert positions are equipped with an 18" wide x 19" high cutout in the back panel as well as two 6" wide x 1" deep grommets along the front edge of the bottom panel for ventilation.

All components finished to match in either a veneer or satin lacquer finish.

4 Position Credenzas

35" High

description	type	d	w	h	pattern no.
4 Positions with File Drawer, Hinge Door, Pull Out-Trash & Box Drawers configuration options, 35" High	4 x 18" wide inserts	24"	73 3/4"	35"	07CRM352474

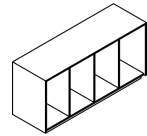

4 Positions with AV Hinge door, Cool Drawer, File Drawer, Hinge Door, Pull Out-Trash and Box Drawers configuration options, 35" High	2 x 18" w inserts & 2 x 24" w inserts on both ends	24"	85 1/4"	35"	07CRM352486
	3 x 18" w inserts & 1 x 24" w insert on the left	24"	79 1/4"	35"	07CRM352480L
	3 x 18" w inserts & 1 x 24" w insert on the right	24"	79 1/4"	35"	07CRM352480R

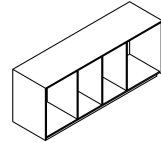

Painted	T1	T2
\$5,581.	\$7,112.	\$8,447.

6,146.	7,776.	9,274.
5,875.	7,444.	8,865.
5,875.	7,444.	8,865.

Order Code

Example:	07CRM352474
07	JD Collection
CR	Credenza
M	Modular
35	35" High
24	24" Deep
74	74" Wide

Specification Information

To order please specify pattern number including:

1. Case Finish
2. Front Finish
3. Position 1 insert configuration
4. Position 2 insert configuration
5. Position 3 insert configuration
6. Position 4 insert configuration
7. Pull Finish

Positions are specified left to right. Please refer to page 58 to 67 for insert configuration codes.

Pull finish only applies to the following insert configuration types: file drawer, box drawer, pull out trash and cool drawer.

Please refer to Materials and Finishes page 7 for specification details.

Pricing Tiers

Painted Case
T1 = Tier 1 veneer case
T2 = Tier 2 veneer case

Pull Finish Options:
HBN = Brushed Nickel
HMB = Matt Black

Note that the credenzas are priced as modular components. The prices listed above are the case prices. The inserts are priced separately. Please refer to page 58 to 67 for insert pricing.

Application Notes

Construction:
 Top and end panels are 3/4" thick wood panels with mitered corners.

Bottom panel is a 3/4" thick wood panel that is butt-jointed to the end panels.

Back panel is a 3/4" thick inset wood panel, picture-framed by the top and end panels exposing the mitered corners while the bottom panel is set back and hidden from view behind the back panel.

Back panel is picture-framed by the top and end panels exposing the mitered corners while the bottom panel set back and hidden from view behind the back panel.

Bases are 2" high wood panels recessed 2" on all sides.

A/V Rack and/or Cool Drawer 24" wide insert positions are equipped with an 18" wide x 19" high cutout in the back panel as well as two 6" wide x 1" deep grommets along the front edge of the bottom panel for ventilation.

All components finished to match in either a veneer or satin lacquer finish.

5 Position Credenzas 29" High

description	type	d	w	h	pattern no.
5 Positions with File Drawer, Hinge Door, Pull Out-Trash & Box Drawers configuration options, 29" High	5 x 18" wide inserts	24"	91 3/4"	29"	07CRM292492

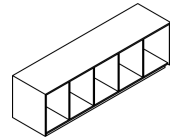

5 Positions with AV Hinge door, Cool Drawer, File Drawer, Hinge Door, Pull Out-Trash and Box Drawers configuration options, 29" High	3 x 18" w insert & 2 x 24" w inserts on both ends	24"	103 3/4"	29"	07CRM2924104
	4 x 18" w inserts & 1 x 24" w insert on the left	24"	97 3/4"	29"	07CRM292498L
	4 x 18" w inserts & 1 x 24" w insert on the right	24"	97 3/4"	29"	07CRM292498R

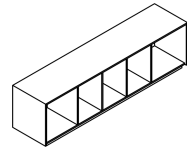

	Painted	T1	T2
	\$5,813.	\$7,393.	\$8,842.
	6,267.	7,954.	9,563.
	6,039.	7,673.	9,204.
	6,039.	7,673.	9,204.

Order Code	Specification Information
Example: 07CRM292492	<i>To order please specify pattern number including:</i>
07 JD Collection	Pricing Tiers
CR Credenza	Painted Case
M Modular	T1 = Tier 1 veneer case
29 29" High	T2 = Tier 2 veneer case
24 24" Deep	<i>Pull Finish Options:</i>
92 92" Wide	HBN = Brushed Nickel
	HMB = Matt Black
	1. Case Finish
	2. Front Finish
	3. Position 1 insert configuration
	4. Position 2 insert configuration
	5. Position 3 insert configuration
	6. Position 4 insert configuration
	7. Position 5 insert configuration
	8. Pull Finish
	Positions are specified left to right. Please refer to page 58 to 67 for insert configuration codes.
	Pull finish only applies to the following insert configuration types: file drawer, box drawer, pull out trash and cool drawer.
	Please refer to Materials and Finishes page 7 for specification details.

Application Notes
Construction: Top and end panels are 3/4" thick wood panels with mitered corners.
Bottom panel is a 3/4" thick wood panel that is butt-jointed to the end panels.
Back panel is a 3/4" thick inset wood panel, picture-framed by the top and end panels exposing the mitered corners while the bottom panel is set back and hidden from view behind the back panel.
Back panel is picture-framed by the top and end panels exposing the mitered corners while the bottom panel set back and hidden from view behind the back panel.
Bases are 2" high wood panels recessed 2" on all sides.
A/V Rack and/or Cool Drawer 24" wide insert positions are equipped with an 18" wide x 19" high cutout in the back panel as well as two 6" wide x 1" deep grommets along the front edge of the bottom panel for ventilation.
All components finished to match in either a veneer or satin lacquer finish.

5 Position Credenzas 35" High

description	type	d	w	h	pattern no.
5 Positions with File Drawer, Hinge Door, Pull Out-Trash & Box Drawers configuration options, 35" High	5 x 18" wide inserts	24"	91 3/4"	35"	07CRM352492

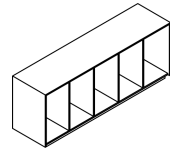

5 Positions with AV Hinge door, Cool Drawer, File Drawer, Hinge Door, Pull Out-Trash and Box Drawers configuration options, 35" High	2 x 18" w insert & 2 x 24" w inserts on both ends	24"	103 3/4"	35"	07CRM3524104
	4 x 18" w inserts & 1 x 24" w insert on the left	24"	97 3/4"	35"	07CRM352498L
	4 x 18" w inserts & 1 x 24" w insert on the right	24"	97 3/4"	35"	07CRM352498R

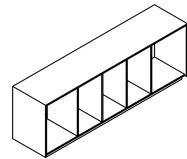









	Painted	T1	T2
	\$6,412.	\$8,096.	\$9,683.
	6,946.	8,746.	10,507.
	6,684.	8,415.	10,101.
	6,684.	8,415.	10,101.

Order Code	Specification Information
Example: 07CRM352492 07 JD Collection CR Credenza M Modular 35 35" High 24 24" Deep 92 92" Wide	<p><i>To order please specify pattern number including:</i></p> <ol style="list-style-type: none"> 1. Case Finish 2. Front Finish 3. Position 1 insert configuration 4. Position 2 insert configuration 5. Position 3 insert configuration 6. Position 4 insert configuration 7. Position 5 insert configuration 8. Pull Finish <p>Positions are specified left to right. Please refer to page 58 to 67 for insert configuration codes.</p> <p>Pull finish only applies to the following insert configuration types: file drawer, box drawer, pull out trash and cool drawer.</p> <p>Please refer to Materials and Finishes page 7 for specification details.</p>
	<p>Pricing Tiers</p> <p>Painted Case T1 = Tier 1 veneer case T2 = Tier 2 veneer case</p> <p><i>Pull Finish Options:</i> HBN = Brushed Nickel HMB = Matt Black</p> <p>Note that the credenzas are priced as modular components. The prices listed above are the case prices. The inserts are priced separately. Please refer to page 58 to 67 for insert pricing.</p>

Application Notes
<p>Construction: Top and end panels are 3/4" thick wood panels with mitered corners.</p> <p>Bottom panel is a 3/4" thick wood panel that is butt-jointed to the end panels.</p> <p>Back panel is a 3/4" thick inset wood panel, picture-framed by the top and end panels exposing the mitered corners while the bottom panel is set back and hidden from view behind the back panel.</p> <p>Back panel is picture-framed by the top and end panels exposing the mitered corners while the bottom panel set back and hidden from view behind the back panel.</p>
<p>Bases are 2" high wood panels recessed 2" on all sides.</p> <p>A/V Rack and/or Cool Drawer 24" wide insert positions are equipped with an 18" wide x 19" high cutout in the back panel as well as two 6" wide x 1" deep grommets along the front edge of the bottom panel for ventilation.</p> <p>All components finished to match in either a veneer or satin lacquer finish.</p>

Credenza Inserts 29" High

description	type	d	w	h	configuration code.	Painted	T1	T2
1 x File Drawer & 2 x Box Drawer 	29"h insert	24"	18"	29"	18FBBMB	\$1,619.	\$1,841.	\$1,960.
1 x File Drawer & 1 x Box Drawer & 1 x Open Shelf 	29"h insert	24"	18"	29"	18FBOMB	1,487.	1,718.	1,838.
2 x File Drawers 	29"h insert	24"	18"	29"	18FFMB	1,479.	1,697.	1,816.
1 x File Drawer & 1 x Open Shelf 	29"h insert	24"	18"	29"	18FOMB	1,303.	1,534.	1,653.
1 x Left Hinged Door 	29"h insert	24"	18"	29"	18HL	1,131.	1,362.	1,481.
1 x Right Hinged Door 	29"h insert	24"	18"	29"	18HR	1,131.	1,362.	1,481.
1 x Left Hinged Door & 1 x Box drawer 	29"h insert	24"	18"	29"	18HBLMB	1,315.	1,546.	1,666.
1 x Right Hinged Door & 1 x Box Drawer 	29"h insert	24"	18"	29"	18HBRMB	1,315.	1,546.	1,666.

Specification Information

The above insert configuration codes are included in the pattern string of the modular credenzas on pages 46 to 56. Note that insert configuration prices should be added onto 3-position, 4-position and 5-position case prices.

Pricing Tiers

Painted Case
T1 = Tier 1 veneer case
T2 = Tier 2 veneer case

Application Notes

End panels are 3/4" thick wood panels.
Horizontal divider panels are 3/4" thick wood panels.
Shelves are 1" thick wood panels and adjustable in 32 mm (1 1/4") increments with a nominal minimum clearance of 6" on top or bottom.

Drawer and door fronts are 3/4" thick wood panels.

Drawers constructed using 1/2" thick wood panels for the front, back and sides with a 3/16" thick wood bottom.

File and box drawers run on fully concealed, under-mounted, full-extension, soft-closing slides rated for 110 pounds per pair.

Drawers and pull-out trash are equipped with pulls.







Hinged doors use 110" free-swing hinges with touch-latch and no pulls.

Fronts are inset 1/4" from the front of the case, creating an iconic and unique aesthetic detail.

Fronts can be specified with a different veneer or satin lacquer finish then the case.

Interior components are finished to match the front in a veneer or satin lacquer finish.

Credenza Inserts 29" High

description	type	d	w	h	configuration code.	Pricing		
						Painted	T1	T2
1 x Left Hinged Door & 1 x Open Shelf 	29"h insert	24"	18"	29"	18HOL	\$1,131.	\$1,362.	\$1,481.
1 x Right Hinged Door & 1 x Open Shelf 	29"h insert	24"	18"	29"	18HOR	1,131.	1,362.	1,481.
1 x Pull-Out Trash 	29"h insert	24"	18"	29"	18TMB	1,594.	1,824.	1,945.
AV Left Hinged Door 	29"h insert	24"	24"	29"	24AL	1,176.	1,407.	1,526.
AV Right Hinged Door 	29"h insert	24"	24"	29"	24AR	1,176.	1,407.	1,526.
Refrigerator Drawer & 1 x Box Drawer 	29"h insert	24"	24"	29"	24CBMB	4,544.	4,781.	4,895.
Refrigerator Drawer & 1 x Open Shelf 	29"h insert	24"	24"	29"	24COMB	4,544.	4,781.	4,895.

Specification Information

The above insert configuration codes are included in the pattern string of the modular credenzas on pages 46 to 56. Note that insert configuration prices should be added onto 3-position, 4-position and 5-position case prices.

Pricing Tiers

Painted Case
T1 = Tier 1 veneer case
T2 = Tier 2 veneer case

Application Notes

End panels are 3/4" thick wood panels.
Horizontal divider panels are 3/4" thick wood panels.
Shelves are 1" thick wood panels and adjustable in 32 mm (1 1/4") increments with a nominal minimum clearance of 6" on top or bottom.

Drawer and door fronts are 3/4" thick wood panels.

Drawers constructed using 1/2" thick wood panels for the front, back and sides with a 3/16" thick wood bottom.

File and box drawers run on fully concealed, under-mounted, full-extension, soft-closing slides rated for 110 pounds per pair.

Drawers and pull-out trash are equipped with pulls.

Hinged doors use 110" free-swing hinges with touch-latch and no pulls.







Fronts are inset 1/4" from the front of the case, creating an iconic and unique aesthetic detail.

Fronts can be specified with a different veneer or satin lacquer finish than the case.

Interior components are finished to match the front in a veneer or satin lacquer finish.

Credenza Inserts

35" High

description	type	d	w	h	configuration code.	Pricing		
						Painted	T1	T2
2 x File Drawer & 1 x Box Drawer 	35"h insert	24"	18"	35"	18FFBMB	\$1,710.	\$1,946.	\$2,090.
2 x File Drawers & 1 x Open Shelf 	35"h insert	24"	18"	35"	18FFOMB	1,525.	1,761.	1,903.
1 x Left Hinged Door 	35"h insert	24"	18"	35"	18HLh †	1,173.	1,421.	1,560.
1 x Right Hinged Door 	35"h insert	24"	18"	35"	18HR †	1,173.	1,421.	1,560.
1 x Left Hinge Door & 1 x File Drawer 	35"h insert	24"	18"	35"	18HFLMB	1,408.	1,662.	1,806.
1 x Right Hinge Door & 1 x File Drawer 	35"h insert	24"	18"	35"	18HFRMB	1,408.	1,662.	1,806.
1 x Left Hinge Door & 1 x Box Drawer & Open Shelf 	35"h insert	24"	18"	35"	18HBOLMB	1,367.	1,620.	1,760.

Specification Information

The above insert configuration codes are included in the pattern string of the modular credenzas on pages 46 to 56. Note that insert configuration prices should be added onto 3-position, 4-position and 5-position case prices.

† Note that the insert code is the same for 29" and 35" high credenzas as the height is part of the base pattern number.

Pricing Tiers

Painted Case
T1 = Tier 1 veneer case
T2 = Tier 2 veneer case

Application Notes

End panels are 3/4" thick wood panels.

Horizontal divider panels are 3/4" thick wood panels.

Shelves are 1" thick wood panels and adjustable in 32 mm (1 1/4") increments with a nominal minimum clearance of 6" on top or bottom.

Drawer and door fronts are 3/4" thick wood panels.

Drawers constructed using 1/2" thick wood panels for the front, back and sides with a 3/16" thick wood bottom.

File and box drawers run on fully concealed, under-mounted, full-extension, soft-closing slides rated for 110 pounds per pair.

Drawers and pull-out trash are equipped with pulls.

Hinged doors use 110" free-swing hinges with touch-latch and no pulls.







Fronts are inset 1/4" from the front of the case, creating an iconic and unique aesthetic detail.

Fronts can be specified with a different veneer or satin lacquer finish than the case.

Interior components are finished to match the front in a veneer or satin lacquer finish.

Credenza Inserts

35" High

description	type	d	w	h	configuration code.	Pricing		
						Painted	T1	T2
1 x Right Hinge Door & 1 x Box Drawer & Open Shelf 	35"h insert	24"	18"	35"	18HBORMB	\$1,367.	\$1,620.	\$1,760.
1 x Left Hinged Door & 1 x Open Shelf 	35"h insert	24"	18"	35"	18HOL †	1,181.	1,436.	1,580.
1 x Right Hinged Door & 1 x Open Shelf 	35"h insert	24"	18"	35"	18HOR †	1,181.	1,436.	1,580.
1 x Pull-Out Trash 	35"h insert	24"	18"	35"	18TMB †	1,642.	1,899.	2,036.
AV Left Hinged Door 	35"h insert	24"	24"	35"	24AL †	1,234.	1,462.	1,604.
AV Right Hinged Door 	35"h insert	24"	24"	35"	24AR †	1,234.	1,462.	1,604.

Specification Information

The above insert configuration codes are included in the pattern string of the modular credenzas on pages 46 to 56. Note that insert configuration prices should be added onto 3-position, 4-position and 5-position case prices.

† Note that the insert code is the same for 29" and 35" high credenzas as the height is part of the base pattern number.

Pricing Tiers

Painted Case
T1 = Tier 1 veneer case
T2 = Tier 2 veneer case

Application Notes

End panels are 3/4" thick wood panels.

Horizontal divider panels are 3/4" thick wood panels.

Shelves are 1" thick wood panels and adjustable in 32 mm (1 1/4") increments with a nominal minimum clearance of 6" on top or bottom.

Drawer and door fronts are 3/4" thick wood panels.

Drawers constructed using 1/2" thick wood panels for the front, back and sides with a 3/16" thick wood bottom.

File and box drawers run on fully concealed, under-mounted, full-extension, soft-closing slides rated for 110 pounds per pair.

Drawers and pull-out trash are equipped with pulls.

Hinged doors use 110" free-swing hinges with touch-latch and no pulls.

Fronts are inset 1/4" from the front of the case, creating an iconic and unique aesthetic detail.

Fronts can be specified with a different veneer or satin lacquer finish than the case.

Interior components are finished to match the front in a veneer or satin lacquer finish.

Credenza Inserts

description	type	d	w	h	configuration code.
2 x Box Drawers & 1 x File Drawer	35" h insert	24"	24"	35"	24CBBMB



description	type	d	w	h	configuration code.
Refrigerator Drawer & 1 x Box Drawer & Open Shelf	35" h insert	24"	24"	35"	24CBOMB



description	type	d	w	h	configuration code.
Refrigerator Drawer & 1 x Open Shelf	35" h insert	24"	24"	35"	24COMB †



Datesweiser JD Collection

	Painted	T1	T2
	\$4,945.	\$5,199.	\$5,341.

	Painted	T1	T2
	4,762.	5,017.	5,158.

	Painted	T1	T2
	4,575.	4,834.	4,974.

Specification Information

The above insert configuration codes are included in the pattern string of the modular credenzas on pages 46 to 56. Note that insert configuration prices should be added onto 3-position, 4-position and 5-position case prices.

† Note that the insert code is the same for 29" and 35" high credenzas as the height is part of the base pattern number.

Pricing Tiers

Painted Case
T1 = Tier 1 veneer case
T2 = Tier 2 veneer case

Application Notes

End panels are 3/4" thick wood panels.

Horizontal divider panels are 3/4" thick wood panels.

Shelves are 1" thick wood panels and adjustable in 32 mm (1 1/4") increments with a nominal minimum clearance of 6" on top or bottom.

Drawer and door fronts are 3/4" thick wood panels.

Drawers constructed using 1/2" thick wood panels for the front, back and sides with a 3/16" thick wood bottom.

File and box drawers run on fully concealed, under-mounted, full-extension, soft-closing slides rated for 110 pounds per pair.

Drawers and pull-out trash are equipped with pulls.

Hinged doors use 110" free-swing hinges with touch-latch and no pulls.

Fronts are inset 1/4" from the front of the case, creating an iconic and unique aesthetic detail.

Fronts can be specified with a different veneer or satin lacquer finish then the case.

Interior components are finished to match the front in a veneer or satin lacquer finish.

<i>pattern no.</i>	<i>page</i>	<i>pattern no.</i>	<i>page</i>	<i>pattern no.</i>	<i>page</i>	<i>pattern no.</i>	<i>page</i>
07CRB292456	44	07MR42X96V1642	28	07MR54X96V1330	34	07R48X168V16	12
07CRB292474	44	07MR42X96V2330	26	07MR54X96V1342	34	07R48X168V23	14
07CRB292492	44	07MR42X96V2342	26	07MR54X96V1630	36	07R48X168V26	16
07CRB352456	44	07MR42X96V2630	28	07MR54X96V1642	36	07R48X180V13	10
07CRB352474	44	07MR42X96V2642	28	07MR54X96V2330	34	07R48X180V16	12
07CRB352492	44	07MR48X60V1330	30	07MR54X96V2342	34	07R48X180V23	14
07CRM2924104	54	07MR48X60V1342	30	07MR54X96V2630	36	07R48X180V26	16
07CRM292456	46	07MR48X60V1630	32	07MR54X96V2642	36	07R48X192V13	10
07CRM292462L	46	07MR48X60V1642	32	07MT4254X60V1330	38	07R48X192V16	12
07CRM292462R	46	07MR48X60V2330	30	07MT4254X60V1342	38	07R48X192V23	14
07CRM292468	46	07MR48X60V2342	30	07MT4254X60V1630	40	07R48X192V26	16
07CRM292474	50	07MR48X60V2630	32	07MT4254X60V1642	40	07R48X204V13	10
07CRM292480L	50	07MR48X60V2642	32	07MT4254X60V2330	38	07R48X204V16	12
07CRM292480R	50	07MR48X72V1330	30	07MT4254X60V2342	38	07R48X204V23	14
07CRM292486	50	07MR48X72V1342	30	07MT4254X60V2630	40	07R48X204V26	16
07CRM292492	54	07MR48X72V1630	32	07MT4254X60V2642	40	07R48X216V13	10
07CRM292498L	54	07MR48X72V1642	32	07MT4254X72V1330	38	07R48X216V16	12
07CRM292498R	54	07MR48X72V2330	30	07MT4254X72V1342	38	07R48X216V23	14
07CRM3524104	56	07MR48X72V2342	30	07MT4254X72V1630	40	07R48X216V26	16
07CRM352456	48	07MR48X72V2630	32	07MT4254X72V1642	40	07R48X228V13	10
07CRM352462L	48	07MR48X72V2642	32	07MT4254X72V2330	38	07R48X228V16	12
07CRM352462R	48	07MR48X84V1330	30	07MT4254X72V2342	38	07R48X228V23	14
07CRM352468	48	07MR48X84V1342	30	07MT4254X72V2630	40	07R48X228V26	16
07CRM352474	52	07MR48X84V1630	32	07MT4254X72V2642	40	07R48X240V13	10
07CRM352480L	52	07MR48X84V1642	32	07MT4254X84V1330	38	07R48X240V16	12
07CRM352480R	52	07MR48X84V2330	30	07MT4254X84V1342	38	07R48X240V23	14
07CRM352486	52	07MR48X84V2342	30	07MT4254X84V1630	40	07R48X240V26	16
07CRM352492	56	07MR48X84V2630	32	07MT4254X84V1642	40	07R48X72V13	10
07CRM352498L	56	07MR48X84V2642	32	07MT4254X84V2330	38	07R48X72V16	12
07CRM352498R	56	07MR48X96V1330	30	07MT4254X84V2342	38	07R48X72V23	14
07MBR	42	07MR48X96V1342	30	07MT4254X84V2630	40	07R48X72V26	16
07MFS157797	42	07MR48X96V1630	32	07MT4254X84V2642	40	07R48X84V13	10
07MFST57797	42	07MR48X96V1642	32	07MT4254X96V1330	38	07R48X84V16	12
07MPH24362	42	07MR48X96V2330	30	07MT4254X96V1342	38	07R48X84V23	14
07MR42X60V1330	26	07MR48X96V2342	30	07MT4254X96V1630	40	07R48X84V26	16
07MR42X60V1342	26	07MR48X96V2630	32	07MT4254X96V1642	40	07R48X96V13	10
07MR42X60V1630	28	07MR48X96V2642	32	07MT4254X96V2330	38	07R48X96V16	12
07MR42X60V1642	28	07MR54X60V1330	34	07MT4254X96V2342	38	07R48X96V23	14
07MR42X60V2330	26	07MR54X60V1342	34	07MT4254X96V2630	40	07R48X96V26	16
07MR42X60V2342	26	07MR54X60V1630	36	07MT4254X96V2642	40	07R60X108V13	18
07MR42X60V2630	28	07MR54X60V1642	36	07R48X108V13	10	07R60X108V16	20
07MR42X60V2642	28	07MR54X60V2330	34	07R48X108V16	12	07R60X108V23	22
07MR42X72V1330	26	07MR54X60V2342	34	07R48X108V23	14	07R60X108V26	24
07MR42X72V1342	26	07MR54X60V2630	36	07R48X108V26	16	07R60X120V13	18
07MR42X72V1630	28	07MR54X60V2642	36	07R48X120V13	10	07R60X120V16	20
07MR42X72V1642	28	07MR54X72V1330	34	07R48X120V16	12	07R60X120V23	22
07MR42X72V2330	26	07MR54X72V1342	34	07R48X120V23	14	07R60X120V26	24
07MR42X72V2342	26	07MR54X72V1630	36	07R48X120V26	16	07R60X132V13	18
07MR42X72V2630	28	07MR54X72V1642	36	07R48X132V13	10	07R60X132V16	20
07MR42X72V2642	28	07MR54X72V2330	34	07R48X132V16	12	07R60X132V23	22
07MR42X84V1330	26	07MR54X72V2342	34	07R48X132V23	14	07R60X132V26	24
07MR42X84V1342	26	07MR54X72V2630	36	07R48X132V26	16	07R60X144V13	18
07MR42X84V1630	28	07MR54X72V2642	36	07R48X144V13	10	07R60X144V16	20
07MR42X84V1642	28	07MR54X84V1330	34	07R48X144V16	12	07R60X144V23	22
07MR42X84V2330	26	07MR54X84V1342	34	07R48X144V23	14	07R60X144V26	24
07MR42X84V2342	26	07MR54X84V1630	36	07R48X144V26	16	07R60X156V13	18
07MR42X84V2630	28	07MR54X84V1642	36	07R48X156V13	10	07R60X156V16	20
07MR42X84V2642	28	07MR54X84V2330	34	07R48X156V16	12	07R60X156V23	22
07MR42X96V1330	26	07MR54X84V2342	34	07R48X156V23	14	07R60X156V26	24
07MR42X96V1342	26	07MR54X84V2630	36	07R48X156V26	16	07R60X168V13	18
07MR42X96V1630	28	07MR54X84V2642	36	07R48X168V13	10	07R60X168V16	20

<i>pattern no.</i>	<i>page</i>	<i>pattern no.</i>	<i>page</i>
07R60X168V23	22	24CBMB	60
07R60X168V26	24	24CBOMB	66
07R60X180V13	18	24COMB	60
07R60X180V16	20	24COMB †	66
07R60X180V23	22		
07R60X180V26	24		
07R60X192V13	18		
07R60X192V16	20		
07R60X192V23	22		
07R60X192V26	24		
07R60X204V13	18		
07R60X204V16	20		
07R60X204V23	22		
07R60X204V26	24		
07R60X216V13	18		
07R60X216V16	20		
07R60X216V23	22		
07R60X216V26	24		
07R60X228V13	18		
07R60X228V16	20		
07R60X228V23	22		
07R60X228V26	24		
07R60X240V13	18		
07R60X240V16	20		
07R60X240V23	22		
07R60X240V26	24		
07R60X72V13	18		
07R60X72V16	20		
07R60X72V23	22		
07R60X72V26	24		
07R60X84V13	18		
07R60X84V16	20		
07R60X84V23	22		
07R60X84V26	24		
07R60X96V13	18		
07R60X96V16	20		
07R60X96V23	22		
07R60X96V26	24		
18FBMB	58		
18FBOMB	58		
18FFBMB	62		
18FFMB	58		
18FFOMB	62		
18FOMB	58		
18HBLMB	58		
18HBOLMB	62		
18HBORMB	64		
18HBRMB	58		
18HFLMB	62		
18HFRMB	62		
18HL	58		
18HLh †	62		
18HOL	60		
18HOL †	64		
18HOR	60		
18HOR †	64		
18HR	58		
18HR †	62		
18TMB	60		
18TMB †	64		
24AL	60		
24AL †	64		
24AR	60		
24AR †	64		
24CBBMB	66		

Selling Policy

	<p>This Selling Policy supercedes all previous selling policies. Prices, discounts and product offerings are subject to change without notice.</p>
Terms & Conditions of Sales	<p>Sales by Knoll, Inc. or Knoll North America Corp. ("Seller") of Knoll Product Lines (hereinafter "Products") within the United States and Canada are made only on the terms which are contained in this Selling Policy. Seller hereby gives notice of its objection to any different or additional terms and conditions. This sale is expressly conditional upon Purchaser's assent to the terms and conditions set forth below. Additional terms and conditions may apply to KnollStudio and KnollTextiles orders. These terms and conditions may be modified or supplemented only by a written document signed by an authorized representative of Seller. These terms and conditions supercede any prior and/or contemporaneous agreements or correspondence between Purchaser and Seller. Written quotations expire thirty (30) days from the date of issuance and can be withdrawn by written notice anytime during that period. Where Purchaser and Seller have entered into the Knoll Electronic Terms and Conditions, all orders, acknowledgements, invoices and other business communications placed or transmitted in accordance with the Knoll Electronic Terms and Conditions shall be deemed to be in writing and signed and shall be valid for all purposes as if they were originated and maintained in documentary form.</p>
Ordering Information	<p>All orders must be in writing. The product pattern number(s) contained on Seller's order acknowledgement shall be the final expression of the order.</p>
Order Confirmation	<p>A purchase order is not binding on Seller until Purchaser has received Seller's order confirmation or acknowledgment.</p>
Pricing Policies	<p>List prices are subject to change without notice.</p> <p>List prices shall be those prices in effect on the date of receipt of a complete purchase order unless shipment is requested more than ninety (90) days after order entry in which case prices in effect on the date of shipment apply. List prices include specified freight costs. Unless specified in writing by Seller, no other charges are included in Seller's list prices.</p>
Taxes	<p>All sales, use, excise and other taxes applicable to the sale of the Products shall be paid by Purchaser. If Purchaser claims an exemption from any tax, Purchaser shall submit to Seller the appropriate exemption certificates.</p>
Terms of Payment	<p>Payment for one hundred percent (100%) of the net order amount is due within thirty (30) days of the date of invoice, which is generally issued upon shipment. In case of any discrepancies, such as shortages, and Seller is notified in writing within ten (10) days of receipt of Product, only that portion may be deducted and the balance paid. For orders greater than \$100,000 net, a fifty percent (50%) deposit is due at the time of order placement, with the remainder due within thirty (30) days of the date of invoice.</p> <p>KnollStudio orders less than \$2,000 require payment for one hundred percent (100%) of the net order amount (including any applicable sales tax and charges for inside delivery, special packaging, etc.), due at time of order placement. For KnollStudio orders greater than \$2,000, a one-half (50%) deposit is due at time of order placement with the remainder (including any applicable sales tax and charges for inside delivery, special packaging, etc.) due prior to shipment.</p> <p>If, in the judgment of Seller, Purchaser's financial condition does not justify the terms of the payment, Seller may require full or partial payment in advance.</p> <p>Past due accounts shall be charged one and one-half percent (1.5%) per month, or the highest rate permitted by law, whichever is less, and will be added to the outstanding balance. In the event Purchaser defaults on payment, Purchaser shall be liable for all collection costs, including reasonable attorney's fees and costs.</p>
Changes and Cancellation	<p>Purchase orders may not be changed or cancelled, in whole or in part, without prior written consent of Seller. Changes may effect delivery dates. Expenses incurred because of changes shall be charged to Purchaser. In the event of cancellations, Purchaser will be liable for reasonable cancellation charges established by Seller. Orders for special Product, orders including "COM" (hereinafter defined) material and orders pursuant to expedited delivery programs, may not be canceled.</p>
Delivery/Freight Charges	<p>Prices are List, Free on Board (F.O.B.) from the DatesWeiser factory in Buffalo, New York. Shipping, packaging, inside delivery, uncrating, installation, storage, and sales tax (if applicable) shall be in addition to the list price and shall be itemized and charged separately.</p> <p>Shipping charges will be added to your order. For a shipping quote contact your sales representative, email customerservice@datesweiser.com or call us toll free at 716.891.1700.</p>
Claims	<p>All shipments for Knoll Products within the contiguous United States and Canada are F.O.B. Origin. All risk of loss passes to Purchaser at time of delivery to carrier. Purchaser shall inspect all Products upon receipt and notify Seller within ten (10) working days after receipt of any damage or defects which are, or should be, apparent from an inspection of the Product and its packaging. Failure of Purchaser to notify Seller during the ten (10) working day period shall constitute acceptance of the Products and waiver of any apparent defects, errors or shortages. For all claims relating to Product damaged in transit or for any other claims relating to or arising out of the transportation of the Product, Purchaser must seek recovery from the carrier and Seller has no liability to Purchaser for such claims. Seller may, upon request, assist Purchaser with filing of such claims with the carrier, but Seller will not be liable for any of these transportation related claims.</p>
Seller's Security Interest	<p>Until Seller receives the full payment for the Product, Seller shall have a security interest in the Product. Purchaser agrees to perform all acts, including but not limited to the execution and filing of documentation, which may be necessary to perfect and assure the security interest of Seller.</p>
Returns	<p>The return of Products without a written authorization by Seller shall not be accepted. To receive authorization for Product return, please call Customer Service. All Products that are returned pursuant to a valid authorization shall be subject to a twenty-five percent (25%) of list restocking charge. Products not currently offered for sale by Seller (including COM) shall not be authorized for return. All returned Products must be unused, in original condition and in the original Seller packing cartons. No refund or credit shall be given for damaged Products.</p>
Held Orders/Storage	<p>If Purchaser requests that an order be held or delayed, prices and terms and conditions in effect at the time of shipment shall apply. If Purchaser requests a delay after the time when Seller can defer production, Purchaser will be invoiced for the Product, payable in accordance with standard terms, when the order is ready for shipment. Seller may transfer the Product to storage, in which case all expenses incurred in connection with storage, including demurrage, preparation for storage, storage charges and handling shall be payable by Purchaser upon submission of invoices by Seller. Risk of loss to the Product shall pass to the Purchaser upon delivery of the Product into storage.</p>

Selling Policy

Customer's Own Material	A Purchaser who requests a fabric or other surface material not standard to Seller's line of Products ("COM") must submit samples of the requested material to Seller prior to entry of a purchaser order. Seller shall determine if the material is suitable to its manufacturing processes and meets any requirements of Underwriters Laboratories. If the COM is acceptable, Seller will then establish a price for using the COM or the Product in question. For a description of the procedures for submitting samples and testing, contact customer resources or your sales representative. Seller shall have no responsibility for the appearance, condition, performance, durability, colorfastness or any other physical attribute of the COM. Purchaser shall indemnify and hold Seller harmless for any damages, injuries or losses arising out of or related to use of the COM on the Product.
Warranty	<p>Seller warrants to the original Purchaser only that the Products Seller manufactures and sells to Purchaser are free of defects in workmanship and materials, during the applicable warranty period set forth below.</p> <p>Warranty period set forth below is for 24-hour, 7 days a week, multi shift use (includes parts and labor to repair).</p> <p>Should any failure to conform with this limited warranty appear to a Product listed below during the applicable warranty period from the date of shipment, Seller shall, upon prompt written notice, repair or replace, at its option and costs, the affected part or parts.</p> <p>Product and Period of Warranty</p> <p>Lifetime: <i>Antenna Workspaces, AutoStrada, Calibre, Crinion Open Table, Currents, Dividends Horizon, Morrison, Reff Profiles</i> laminate, <i>Rockwell Unscripted, Series 2 Storage, Template, Quoin</i> and other non-wood components (except cascade edge worksurfaces, operational parts, controls, electrical, Lighting, <i>Series 2 Veneer Front Storage</i>, digital locks, upholstery, textiles and leathers, special or custom products, see below), <i>Islands Collection</i> table structure, legs, and laminate worksurfaces; and <i>Wexby</i> mobile bin.</p> <p>12 Years: <i>Chadwick, Generation by Knoll, k. task, Life, Newson Task, Moment, MultiGeneration by Knoll, Ollo, ReGeneration by Knoll, Remix, and Toboggan</i> seating (except seating upholstery, textiles, leathers and finishes, see below).</p> <p>10 Years: <i>Anchor Storage</i> except digital locks, <i>Antenna Workspaces, AutoStrada, Crinion Open Table, Dividends Horizon, Dividends Horizon Satellite Surfaces, Reff Profiles, Rockwell Unscripted, Quoin</i> wood components, <i>Template</i> wood components, <i>Series 2 Veneer Front Storage</i>, cascade edge worksurfaces, <i>Wood Casegoods</i> (The Graham Collection) (except wood casegoods upholstered surfaces, see below), <i>Reuter</i> overheads, <i>Reuter</i> vertical storage, <i>KnollExtra</i> Sapper Monitor Arm Collection, Sapper XYZ Monitor Arm Series, Adjustable keyboard mechanisms and platforms, Communication Boards (except fabric board textiles, cork and FilzFelt, see below), Smokador collection (except leathers, see below), Orchestra Universal Systems Accessories, <i>k. lounge</i> structural components, <i>KnollStudio</i> Pixel and Propeller, <i>Antenna Telescope</i> bases, <i>Tone</i> bases, <i>k.screens</i>, and dealer-purchased non BIFMA-certified <i>Muuto</i> products.</p> <p>5 Years: Operational parts, controls, electrical, Lighting (except light ballasts, bulbs and power supply, see below), special or custom product, wood veneer products and plywood, <i>Currents</i> handcrank, <i>KnollStudio</i> (excluding textiles, leather and outdoor finishes), <i>LSM, Pixel Lounge, Rockwell Unscripted</i> wire bases, <i>KnollExtra</i> CPU holders and all universal storage drawers, and <i>Power Collection, k.bench</i> (except changes in finish, see below) and <i>k.stand</i> bases (except changes in finish, see below), <i>Islands Collection</i> veneer worksurfaces, operational parts, wide grommet lid, castors, glides and electrical; and dealer-purchased non BIFMA-certified <i>Muuto</i> products.</p> <p>3 Years: <i>Rockwell Unscripted</i> upholstery (except textiles and leather), <i>Office Seating</i> upholstery, textiles, leathers and finishes. Fabric boards textiles and Smokador Collection leathers, <i>KnollExtra</i> Pop Up Screens, <i>k.screen</i> (except cork and PET), and retailer-purchased <i>Muuto</i> products.</p> <p>2 Years: <i>Anchor Storage</i> digital locks, <i>Quoin</i> digital locks, all other <i>KnollExtra</i> product.</p> <p>1 Year: Light ballasts, bulbs and power supply, seating upholstered armpads and soft armpads, wood casegoods, upholstered surfaces, <i>KnollStudio</i>, textiles, leathers and outdoor product finishes, <i>Pixel Lounge</i> fabric, <i>k. lounge</i> upholstery and <i>k. lounge</i> fabric, <i>Rockwell Unscripted</i> fabric and accessories, <i>k.screen</i> cork and PET.</p> <p>This warranty does not apply to:</p> <ul style="list-style-type: none">• Damage caused by a carrier other than the Seller.• Normal wear and tear or acts or omissions of parties other than Seller (including user modification, improper use or installation of Products).• COM or other third party materials applied to Products.• Products not installed by or under the auspices of a Knoll Dealer.• Dramatic temperature variations or exposure to unusual conditions.• Changes in surface finishes, including colorfastness due to aging or exposure to light.• Except as specifically noted above, textiles and upholstery supplied by <i>KnollTextiles</i> and Spinneybeck FilzFelt (consult current price lists for applicable warranties). <p>Natural variations occurring in wood, marble, and leather shall not be considered defects, and the Seller does not guarantee the colorfastness or matching of the colors, grains or textures, or surface hardness of such materials. The Seller also does not guarantee the colorfastness of fiberglass panel surfaces.</p> <p>THE EXPRESS WARRANTIES CONTAINED HEREIN ARE IN LIEU OF ALL OTHER WARRANTIES, EXPRESS OR IMPLIED, INCLUDING ANY WARRANTIES OF MERCHANTABILITY AND FITNESS FOR PARTICULAR PURPOSE AND ALL OTHER WARRANTIES ARISING FROM COURSE OF DEALING OR USAGE OF TRADE.</p> <p>The remedies provided above are the Purchaser's sole remedies for any failure of Seller to comply with its obligations regarding the workmanship of its Products. Correction of any nonconformity in the manner and for the period of time provided shall constitute complete fulfillment of all liabilities of Seller, with respect to or arising out of the Product furnished hereunder.</p>
Delay/Force Majeure	Seller shall not be liable for failure to perform or for delay in performance due to fire, flood, strike or other labor difficulty, act of God, act of war or terrorism, act of any governmental authority or of the Purchaser, riot, embargo, fuel or energy shortage, wrecks or delay in transportation, inability to obtain necessary labor, materials or manufacturing facilities from usual sources or failure of suppliers to meet their contractual obligations, or due to any cause beyond its reasonable control. If any such event occurs, Seller may extend delivery dates by a period of time necessary to overcome the effect of such delay, allocate available Product or cancel any purchase order.
Compliance with Law	PURCHASER IS SOLELY RESPONSIBLE FOR COMPLIANCE WITH ALL APPLICABLE FEDERAL, STATE AND LOCAL LAWS, ORDINANCES, REGULATIONS, RULES AND STANDARDS RELATING TO THE INSTALLATION, MAINTENANCE, USE AND OPERATION OF THE PRODUCTS.
Patents	Subject to the following provisions, Seller shall, at its own expense, defend or, at its option, settle any claim, suit or proceeding brought against the Purchaser, and/or its vendees, mediate and immediate, so far as based on an allegation that any Product or any part thereof furnished hereunder constitutes a direct or a contributory infringement of any claim of any patent of the United States or Canada. This obligation shall be effective only if Purchaser shall have made all

Selling Policy

payments then due hereunder and if Seller is notified promptly in writing and given authority, information and assistance for the defense of said claim, suit or proceeding. Seller shall pay all damages and costs awarded in such suit or proceedings so defended.

The foregoing indemnity does not apply to the following:

- Products supplied according to a design other than that of Seller, and which is required by the Purchaser.
- Combination of the Product with another product not furnished hereunder unless Seller is a contributory infringer.
- Any settlements of a suit or proceeding made without Seller's written consent.

Limitations of Liability

SELLER, ITS CONTRACTORS, AUTHORIZED DEALERS AND SUBCONTRACTORS OR SUPPLIERS OF ANY TIER SHALL NOT BE LIABLE TO PURCHASER FOR ANY SPECIAL, INDIRECT, INCIDENTAL OR CONSEQUENTIAL DAMAGES ARISING FROM A BREACH OF THIS AGREEMENT.

Purchaser's remedies set forth herein are exclusive and the liability of Seller with respect to the breach of this agreement or any contract entered into between the parties pursuant hereto shall not exceed the price of the Product or part on which such liability is based.

General Ordering Information

The Products

This guide encompasses all standard products for this product group.

Sizes

Dimensions listed in this guide are indicated as:

H = height

W = width

D = depth

Dia. = diameter

Rad. = radius

Pricing

All prices shown are list.

How to Order

Select pattern numbers and quantities required for your complete installation. Product questions can be addressed in the specific sections of this guide or by contacting your sales representative or customer resource representative at 1-800-343-5665.

Next, select options (if required), along with colors and finishes appropriate to each product. Reference the Finishes and Fabrics pages for color designations.

On large installations, an item's "designated area" can be specified to assist in product organization and handling.

To expedite complete / correct entry of your order, be certain all pattern numbers, quantities, colors and area identifications are completely specified. Also, include complete purchase order numbers, bill-to and ship-to addresses, a contact name and specific factory shipping dates required.

Mail all orders to:

Knoll, Inc.

1235 Water Street

P.O. Box 157

East Greenville, PA 18041

Attention: Order Entry

Once your order is entered at Knoll, an acknowledgment will be mailed to you. You will be advised of your scheduled shipping date within five days of the original acknowledgment. If it is necessary to revise your order, please contact your customer resource representative.

Sustainability Statement

Sustainable design is a key component of Knoll's environmental focus. Our commitment to social responsibility and a healthy environment has prompted us to further articulate our longstanding environmental programs and, with encouragement and support from our colleagues in the industry, we have re-energized our focus on such "green" initiatives as life cycle analysis and LEED™ certification. Knoll is proud to have contributed to projects that have received LEED certification from the U.S. Green Building Council.

For the latest information on Knoll products that help our customers achieve LEED certification, log on to knoll.com, click on "About Knoll" and then "Environmental Focus."